



MANUAL



Set of EMC-glands as an option

CONTROL UNIT FOR ROTARY HEAT EXCHANGER

MicroMax750

Article no. F21075401

IBCcontrol



TABLE OF CONTENTS

Installation instructions	2
Mounting	2
Safety instructions	3
Manufacturer's declaration	4
Description of functions	5
Technical data	6
Functions	6
- DIP switch	7
- Operational indications	7
- Alarms	8-9
- Settings via potentiometer	9
- Push button	9
Connection diagram	10
Connections	10
Checks before powering up the control unit	11
Putting the equipment into operation	11
EMC installation	12
EMC gland	12
Personal notes	13

INSTALLATION INSTRUCTIONS

Warning indication



The control unit may only be used in perfect technical condition. Any damage that may affect safety must be dealt with immediately.

Maintenance/Repairs

The function of the control unit should be checked regularly. Troubleshooting and repairs may only be performed by trained personnel. Electrical safety regulations must be met.

Disposal and recycling

When replacing components or when the control unit in its entirety need replacing, please follow the advice below: The aim should always be maximum possible recycling of raw materials, with minimum possible environmental impact. Never dispose of electrical components with ordinary waste, always use the designated collection points. Disposal should be as environment-friendly as the technology allows in terms of environmental protection and recycling.

MOUNTING

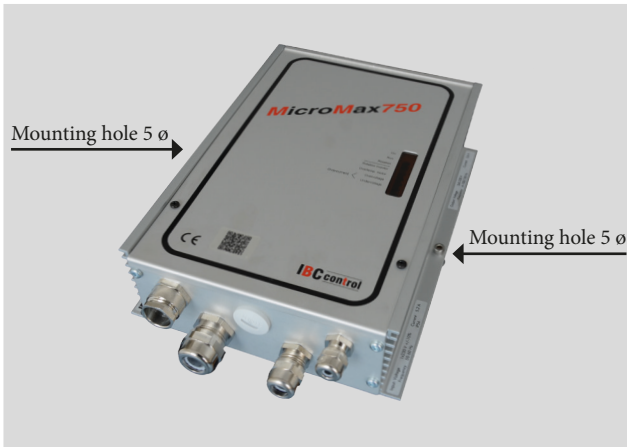

SAFETY INSTRUCTIONS

The following symbols and references are used in this description. These instructions are important; they apply to personal and technical safety during operation.



Safety instruction refers to instructions whose specific intent is to avoid the risk of personal injury and to prevent damage to equipment.



Danger! Electrical current to electrical components!
Note: Switch off main power before removing the cover.

Never touch electrical components or contacts while main current is switched on. Risk of electric shock, resulting in serious injury or death.

Residual voltage remains in connected terminals even after main power has been switched off.

MANUFACTURER'S DECLARATION

Manufacturer IBC control AB
Brännerigatan 5 A, SE-263 37 Höganäs, Sweden

Product Control unit for rotary heat exchanger

Type designation MicroMax750

Article number F21075401

EU directive applied to the product The manufacturer's declaration of conformity with the requirements of the EMC Directive 2004/108/EC.

All control units are approved according to the requirements of the EMC Directive 2004/108/EC and are tested according to standard EN 61800-3:2004, emission category C1 and immunity category C2.

All control units comply with the Low Voltage Directive 2006/95/EC, standard EN 61800-5-1.

All control units are designed for installation in environments subject to pollution degree 2.

This product also complies with RoHS Directive 2011/65/EU.

Höganäs 2015-07-01

IBC control AB



Christer Persson

MD

DESCRIPTION OF FUNCTIONS

- The MicroMax750 is part of a range of control units adapted, with the necessary additional functions, for optimum control of rotary heat exchangers. The series consists of four sizes, MicroMax, MicroMax180, MicroMax370 and MicroMax750. All of the control units drive three-phase induction motors with associated gearing; the control unit designation denotes motor output. All control units have an input signal of 0-10 V.
- MicroMax750 is designed for wheels up to 5000 mm mm with a wheel speed of max 12 rpm. If a faster wheel speed is necessary, rotor diameter should be reduced.
- Heat exchanger rpm and thus thermal efficiency are governed by the control unit so that wheel speed is proportional to the input signal from the control centre.
- MicroMax750 has a preset threshold value of 0.1 V (hysteresis 0.13–0.07 V). If the input signal falls below this value, the wheel will stop.
- MicroMax750 has a rotation monitor (magnet mounted on the wheel with associated magnetic sensor) and built-in cleaning function. The functions can be disconnected via DIP switches.
- MicroMax750 starts automatically following voltage drop-out, and resets all alarms on restart.
- The motor should not be disconnected from the control unit while under load.

TECHNICAL DATA

Connection voltage	1x230-240 V +/-15 % 50/60 Hz
Power input, max.	1100 W
Input current, max.	5.0 A
External fuse, max.	10 A
Output voltage*)	3x0-230 V
Min frequency	(Fixed) 4 Hz
Max frequency	40-100/150 Hz
Motor output, max	750 W
Motor current	3.6 A

Overload 2 min/30 min	5.3 A
Internal fuse **)	6.3 AT
Acceleration time	(Fixed) 30 sec
Retardation time	(Fixed) 60 sec
Ambient temperature, non condensing	-20 - +45 °C
Protection form	IP54
Weight	1.2 kg
Dimensions, HxWxD	225x165x60 mm

* Exact value cannot be obtained with a digital measuring instrument

** The fuse protects both motor and electronics

FUNCTIONS

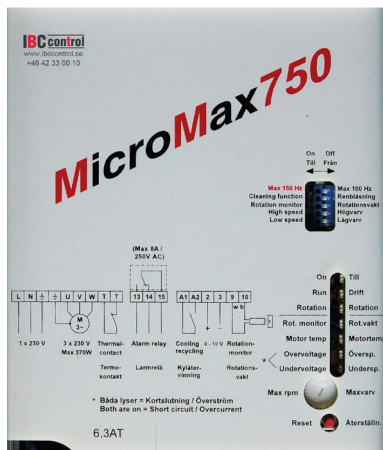

DIP switch

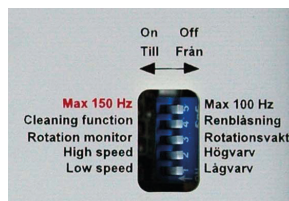

Operational/ Alarm indications

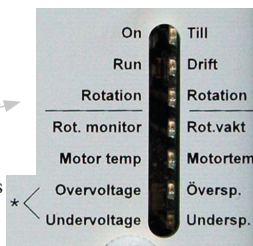

← DIP switch ON to left

← Operational indications

← Alarm indications

← Settings

← Reset button

* Båda lyser = Kortslutning / Överström
Both are on = Short circuit / Overcurrent

DIP SWITCH

Max frequency 100/150 Hz	The default DIP switch setting is 100 Hz. To increase speed, the DIP switched may in special cases be set to 150 Hz This may however result in a shorter service life for the VVX motor.
Cleaning function	Cleaning function set to ON position. When the wheel has stopped for 30 minutes, the cleaning function is activated and the wheel rotates at minimum speed for 10 seconds.
Rotation monitor	Rotation monitor set to ON position.
High speed*)	The wheel rotates at the set maximum rpm when the switch is set to ON. After a test run, make sure the DIP switch is set to OFF.
Low speed*)	The wheel rotates at the fixed minimum rpm when the switch is set to ON. After a test run, make sure the DIP switch is set to OFF.

*) Manual operation (test mode)

OPERATIONAL INDICATIONS

On/alarm	"Power on" is lit continuously. It flashes when the control unit has tripped.
Run	Comes on when the motor is to rotate, i.e. when the input signal exceeds the threshold value.
Rotation	Flashes when the magnet passes the magnetic sensor, regardless of the "Rotation monitor" DIP switch setting. Flashes even if the input signal is lower than the threshold value.

ALARMS

All alarms remain in state.

Rotation monitor	Alarms and trips unless a pulse is received every 5 minutes.
Probable fault cause on installation	<ul style="list-style-type: none">- Magnet facing the wrong way- Magnetic sensor incorrectly connected (wrong polarity), see CONNECTIONS on page 10- Too wide a gap between the magnetic sensor and magnet; max 15 mm
Probable fault cause in operation	<ul style="list-style-type: none">- Broken belt- Belt slipping- Stuck wheel- Magnetic sensor or magnet not intact
Motor temperature	Alarms and trips if motor winding temperature is too high. The thermal contact in the motor reverts to normal mode when the temperature drops.
Probable fault cause	See "Overcurrent" on page 9.
Overvoltage	Alarms and trips if the connection voltage exceeds 276 V for more than 4-5 seconds.
Undervoltage	Alarms and trips if the power supply falls below 195 V for more than 4-5 seconds.
Short circuit/overcurrent Undervoltage and overvoltage both light up	Alarms and trips in the event of a phase-to-phase or phase-to-earth short circuit and overcurrent. Phase-to-phase short circuit MicroMax750 limits current to 7 A, above which it will trip after 4-5 seconds.
Probable fault cause	<ul style="list-style-type: none">- Motor winding fault Measure motor resistance; it should be identical on all phases.- Phase-to-phase short circuit in the cable

Continued on next page

Continued from previous page

Phase-to-earth short circuit

MicroMax750 trips immediately.

Probable fault cause - Earth fault in motor or cable
 In the event of an earth fault, the control unit must be reset with power off.

Overcurrent

MicroMax750 limits current to 7 A, above which it will trip after 4-5 seconds.

Probable fault cause - The motor is too small in relation to rotor diameter
 - Wheel rotation sluggish
 - Damaged motor, e.g. bearing fault
 Measure amperage.

NOTE! Precise voltages and amperages can only be obtained with a moving-iron ammeter.

SETTINGS VIA POTENTIOMETER

Max speed Potentiometer for adjusting max. speed.
 Adjust between 40-100 Hz.
 Factory setting, 50 Hz.

PUSH BUTTON

Reset Reset button for resetting the control unit.
 The control unit also resets in the event of voltage drop-out.
 In both cases, all alarms reset.

CONNECTION DIAGRAM

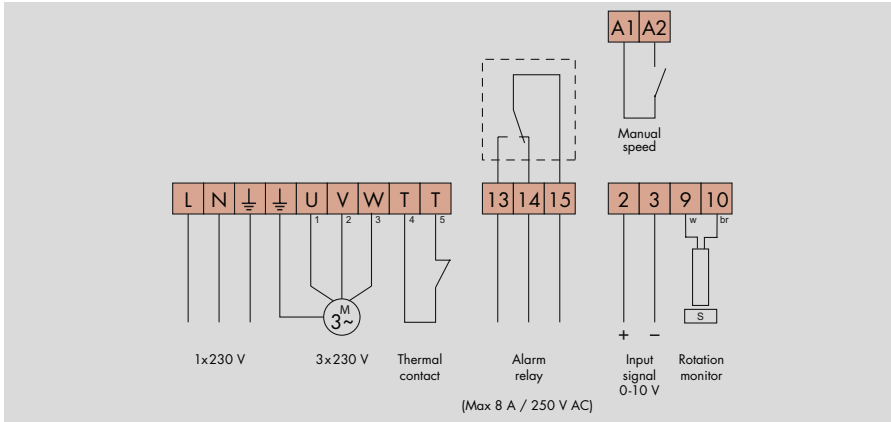

CONNECTIONS



Switch off power before starting work on the equipment.

Recommended tightening torque on terminals 0.5 Nm; max tightening torque 0.8 Nm.

Connection voltage (L-N-PE)	1x230-240 V +/-15 %, 50/60 Hz. NOTE! Protective earth must always be connected.
Motor (U-V-W)	Three-phase induction motor wired for 3x230 V (Delta). Max 750 W. Direction of rotation is changed by switching two of the phases.
Thermal contact (T-T)	The thermal contact in the motor should be used to protect the motor from overheating. Must be jumped if the temperature switch is not connected.
Alarm relay (13-14-15)	Closes between 14-15 in the event of an alarm or voltage drop-out. Max 8 A resistive load / 250 V AC.
Input signal (2-3)	0-10 V. Plus connected to terminal 2, minus to terminal 3.
Rotation monitor (9-10)	White cable connected to terminal 9, brown to terminal 10. The magnet is installed with south side (S) towards the transmitter. Max. gap 15 mm.
Manual speed (A1-A2)	Provides set max rpm when closed, regardless of input signal value.

CHECKS BEFORE POWERING UP THE CONTROL UNIT



Check that	the control unit is connected as per instructions on page 10. Connection voltage 230-240 V +/-15%, 50/60 Hz.
Check that	the motor is wired for 3 x 230 V. If there is an operating switch between the motor and the control unit, the motor thermal contact should be connected via the auxiliary terminal in the operating switch.
Check that	the input signal is 0-10 V.
Check that	the cleaning function and rotation monitor DIP switch are set to ON.
Check that	the frequency DIP switch is set to 100 Hz for normal wheel speed (10-12 rpm).

PUTTING THE EQUIPMENT INTO OPERATION



Should be done in sequence.

Check that	the motor rotates in the right direction in relation to the wheel's direction of rotation. In the event of a fault, switch two phases to the motor.
Adjustment of max. speed	Set the High Speed DIP switch to the ON position. Adjust "Max. speed" so that the wheel rotates at 10-12 rpm (or as per directions from wheel manufacturer). After a test run, set the DIP switch to OFF.
Checking minimum speed	Set the Low Speed DIP switch to ON. Check that the wheel starts. The minimum speed is preset. After a test run, set the DIP switch to OFF.
Checking the cleaning function	Switch off the voltage. Make sure the "Cleaning" DIP switch is set to ON and the input signal is disconnected. When power is switched on, the wheel will rotate at minimum rpm for 10 seconds.
Checking the rotation monitor	The yellow Rotation LED will flash when the magnet passes the magnetic sensor, regardless of DIP switch position.
Finish by	having the control unit drive the wheel at maximum and minimum rotation speed and checking that the wheel speed is correct.

EMC INSTALLATION

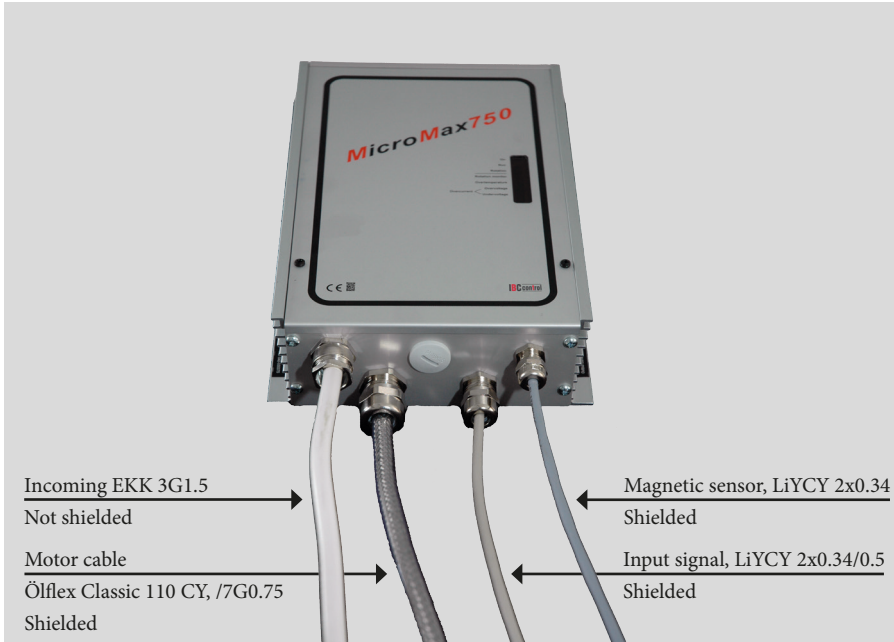

EMC glands must be used for shielded cables.

The above cables or equivalent must be used to comply with the EMC Directive.

EMC GLAND

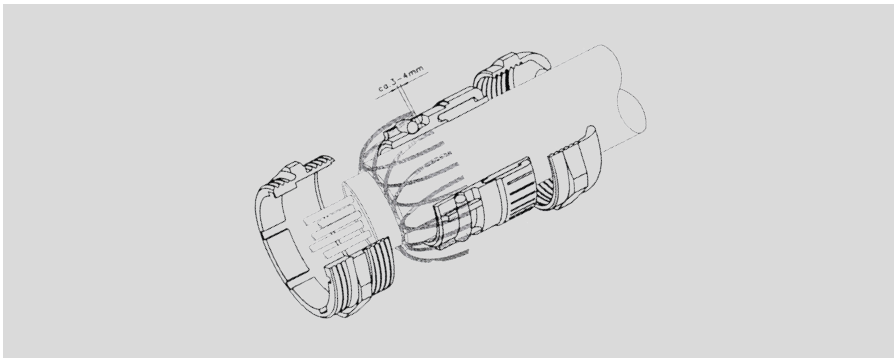

NOTE!

When connecting the shield to the EMC gland, it is important to do so as shown above.



YOUR NOTES



F21075901GB
Version 2.0.1
2018-10-01

IBC control

IBC control AB
Brännerigatan 5 A
SE-263 37 Höganäs
Sweden
Tel. +46 42 33 00 10
www.ibcccontrol.se
info@ibcccontrol.se