

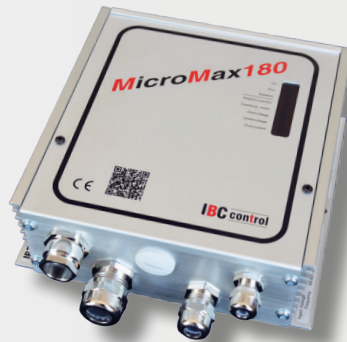

## MANUAL



Set of EMC-glands as an option

CONTROL UNIT FOR ROTARY HEAT EXCHANGER

# MicroMax180

Article no. F21018301

*With adjustable boost function and threshold value*

**IBC**control



## TABLE OF CONTENTS

Installation instructions	2
Mounting	2
Safety instructions	3
Manufacturer's declaration	4
Description of functions	5
Technical data	6
Functions	6
- DIP switch	7
- Operational indications	7
- Alarms	8-9
- Settings via potentiometer	9
- Push button	9
Connection diagram	10
Connections	10
Checks before powering up the control unit	11
Putting the equipment into operation	11
EMC installation	12
EMC gland	12
Personal notes	13

## INSTALLATION INSTRUCTIONS

### Warning indication



The control unit may only be used in perfect technical condition. Any damage that may affect safety must be dealt with immediately.

### Maintenance/Repairs

The function of the control unit should be checked regularly. Troubleshooting and repairs may only be performed by trained personnel. Electrical safety regulations must be met.

### Disposal and recycling

When replacing components or when the control unit in its entirety need replacing, please follow the advice below: The aim should always be maximum possible recycling of raw materials, with minimum possible environmental impact. Never dispose of electrical components with ordinary waste, always use the designated collection points. Disposal should be as environment-friendly as the technology allows in terms of environmental protection and recycling.

## MOUNTING

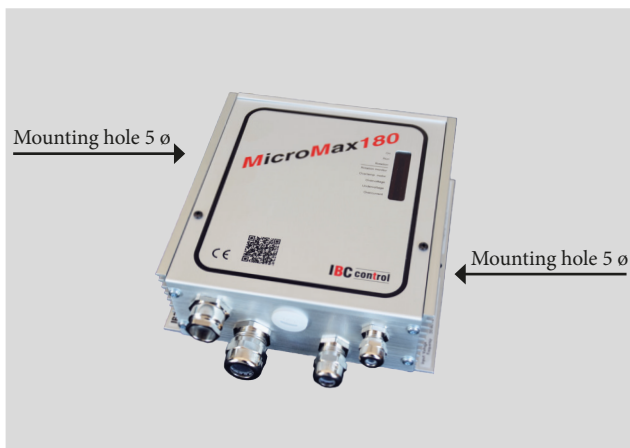

## SAFETY INSTRUCTIONS

The following symbols and references will be used in this description. These important instructions apply to personal protection and technical safety during operation.



“Safety instructions” refers to instructions whose specific intent is to avoid the risk of personal injury and to prevent damage to equipment.



Danger! Electrical current to electrical components!  
Note: Switch off main power before removing the cover.

Never touch electrical components or contacts while main current is switched on. Risk of electric shock, resulting in serious injury or death.

Residual voltage remains in connected terminals even after main power has been switched off.

## MANUFACTURER'S DECLARATION

**Manufacturer** IBC control AB  
Brännerigatan 5 A, SE-263 37 Höganäs, Sweden

**Product** Control unit for rotary heat exchanger

**Type designation** MicroMax180

**Article number** F21018301

**EU directive applied to the product** The manufacturer's declaration of conformity with the requirements of the EMC Directive 2004/108/EC.

All control units are approved according to the requirements of the EMC Directive 2004/108/EC and are tested according to standard EN 61800-3:2004, emission category C1 and immunity category C2.

All control units comply with the Low Voltage Directive 2006/95/EC, standard EN 61800-5-1.

All control units are designed for installation in environments subject to pollution degree 2.

This product also complies with RoHS Directive 2011/65/EU.

Höganäs 2015-07-01  
IBC control AB



Christer Persson  
MD

## DESCRIPTION OF FUNCTIONS

- The MicroMax180 is part of a range of control units adapted, with the necessary additional functions, for optimum control of rotary heat exchangers. The series consists of four sizes, MicroMax, MicroMax180, MicroMax370 and MicroMax750.

All of the control units drive three-phase induction motors with associated gearing, the control unit designation denotes motor output.

All control units have an input signal of 0-10 V.

- MicroMax180 is designed for wheels up to 2500 mm with a wheel speed of max 12 rpm.

If a faster wheel speed is necessary, rotor diameter should be reduced.

- Heat exchanger rpm and thus thermal efficiency are governed by the control unit so that wheel speed is proportional to the input signal from the control centre.

- MicroMax180 has a customisable threshold of 0-2 V.

- MicroMax180 has adjustable boost function.

- MicroMax180 has a rotation monitor (magnet mounted on the wheel with associated magnetic sensor) and built-in cleaning function.

The functions can be disconnected via DIP switches.

- MicroMax180 starts automatically following voltage drop-out and resets all alarms on restart.



- The motor should not be disconnected from the control unit while under load.

## TECHNICAL DATA

Connection voltage	1x230-240 V +/-15 % 50/60 Hz	Ambient temperature, non condensing	-25 - +45 °C
Power input, max.	390 W	Protection form	IP54
Input current, max.	1.7 A	Weight	0.9 kg
External fuse max.	10 A	Dimensions, HxWxD	158x165x60 mm
Output voltage*)	3x0-230 V	* Exact value cannot be obtained with a digital measuring instrument	
Output frequency	5-100 Hz	** The fuse protects both motor and electronics	
Minimum frequency	(Fixed) 5 Hz		
Max frequency	40-100 Hz		
Motor output, max	180 W		
Motor current	1.3 A		
Overload 2 min/30 min	2.1 A		
Internal fuse **)	2.5 AT		
Acceleration time	(Fixed) 30 sec		
Retardation time	(Fixed) 30 sec		

## FUNCTIONS

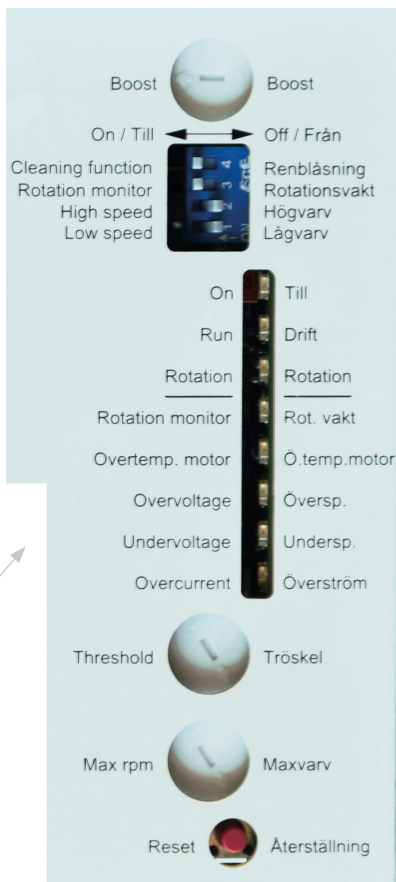
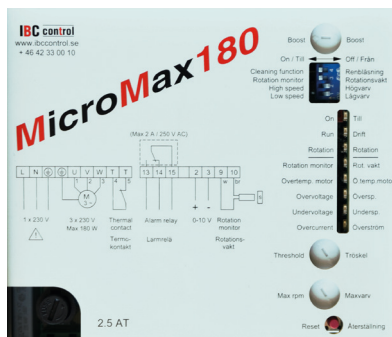



## DIP SWITCH

<b>Cleaning function</b>	Cleaning function set to ON position. When the wheel has stopped for 30 minutes, the cleaning function is activated and the wheel rotates at minimum rpm for 10 seconds.
<b>Rotation monitor</b>	Rotation monitor set to ON position.
<b>High speed*)</b>	The wheel rotates at the set maximum rpm when the switch is set to ON. After a test run, make sure the DIP switch is set to OFF.
<b>Low speed*)</b>	The wheel rotates at the fixed minimum rpm when the switch is set to ON. After a test run, make sure the DIP switch is set to OFF.

\*) Manual operation (test mode)

## OPERATIONAL INDICATIONS

<b>On/alarm</b>	ON is lit continuously. Flashes when the control unit has tripped.
<b>Run</b>	Comes on when the motor is to rotate, i.e. when the input signal exceeds the threshold value.
<b>Rotation</b>	Flashes when the magnet passes the magnetic sensor, regardless of the "Rotation monitor" DIP switch setting. Flashes even if the input signal is lower than the threshold value.

## ALARMS

All alarms remain in state.

<b>Rotation monitor</b>	Alarms and trips unless a pulse is received every 5 minutes.
Probable fault cause on installation	<ul style="list-style-type: none"><li>- Magnet facing the wrong way</li><li>- Magnetic sensor incorrectly connected (wrong polarity), see "Connections" on page 10</li><li>- Too wide a gap between the magnetic sensor and magnet, max 15 mm</li></ul>
Probable fault cause in operation	<ul style="list-style-type: none"><li>- Broken belt</li><li>- Belt slipping</li><li>- Stuck wheel</li><li>- Magnetic sensor or magnet not intact</li></ul>
<b>Overtemperature motor</b>	Alarms and trips if motor winding temperature is too high. The thermal contact in the motor reverts to normal mode when the temperature drops.
Probable fault cause	See "Overcurrent" on page 9.
<b>Overvoltage</b>	Alarms and trips if the connection voltage exceeds 276 V for more than 4-5 seconds.
<b>Undervoltage</b>	Alarms and trips if the connection voltage falls below 195 V for more than 4-5 seconds.
<b>Short circuit/overcurrent</b>	Alarms and trips in the event of a phase-to-phase or phase-to-earth short circuit and overcurrent.  Short circuit phase-phase or phase-earth (earth fault) MicroMax180 trips immediately.
Probable fault cause	<ul style="list-style-type: none"><li>- Motor winding fault Measure motor resistance, it should be identical on all phases.</li><li>- Short circuit between phases in the cable</li><li>- Earth fault in motor or cable</li></ul>

Continued on next page

Continued from previous page

### Overcurrent

MicroMax180 limits current at 2.4 A and trips then after 4-5 s.

Probable fault cause

- The motor is too small in relation to wheel diameter
- Wheel rotation sluggish
- Damaged motor, e.g. bearing fault

Measure current.

---

NOTE! Precise voltages and amperages can only be obtained with a moving-iron instrument.

## SETTINGS VIA POTENTIOMETER

<b>Boost</b>	Torque boost at low rpm. Factory set. May be increased if necessary, but motor temperature will increase.
<b>Threshold value</b>	The control unit will start when the input signal exceeds the threshold value, adjustable between 0-2 V.
<b>Max rpm</b>	Potentiometer for adjusting maximum rpm. Adjust between 40-100 Hz. Factory setting, 50 Hz.

## PUSH BUTTON

**Reset**

Reset button for resetting the control unit.  
The control unit also resets in the event of voltage drop-out.  
In both cases, all alarms reset.  
Automatic restart takes place after a voltage drop-out.



## CONNECTION DIAGRAM

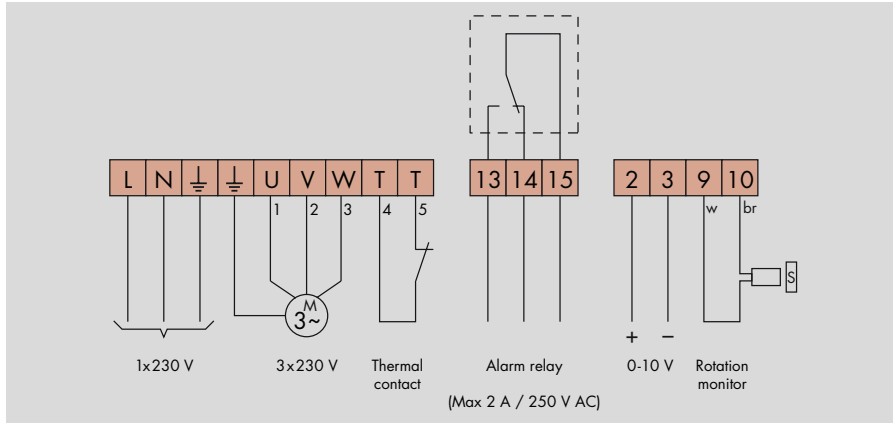

## CONNECTIONS



Switch off power before starting work on the equipment.

Recommended tightening torque on terminals 0.5 Nm, max tightening torque 0.8 Nm.

<b>Connection voltage</b> (L-N-PE)	1x230-240 V +/-15 %, 50/60 Hz. NOTE! Protective earth must always be connected.
<b>Motor</b> (U-V-W)	Three-phase induction motor wired for 3x230 V (Delta). Max 180 W. Direction of rotation is changed by switching two of the phases.
<b>Thermal contact</b> (T-T)	The thermal contact in the motor should be used to protect the motor from overheating. Must be jumped if the temperature switch is not connected.
<b>Alarm relay</b> (13-14-15)	Closes between 14-15 in the event of an alarm or voltage drop-out. Max 2 A resistive load / 250 V AC.
<b>Input signal</b> (2-3)	0-10 V. Plus connected to terminal 2, minus to terminal 3.
<b>Rotation monitor</b> (9-10)	White cable connected to terminal 9, brown to terminal 10. The magnet is installed with south side (S) towards the sensor. Max. gap 15 mm.



## CHECKS BEFORE POWERING UP THE CONTROL UNIT



<b>Check that</b>	the control unit is connected as per instructions on page 10. Connection voltage 230-240 V +/-15%, 50/60 Hz.
<b>Check that</b>	the motor is wired for 3 x 230 V. If there is an operating switch between the motor and the control unit, the motor thermal contact should be connected via the auxiliary terminal in the operating switch.
<b>Check that</b>	the input signal is 0-10 V.
<b>Check that</b>	the cleaning function and rotation monitor DIP switch are set to ON.

## PUTTING THE EQUIPMENT INTO OPERATION



Should be done in sequence.

<b>Check that</b>	the motor rotates in the right direction in relation to the wheel's direction of rotation. In the event of a fault, switch two phases to the motor.
<b>Adjustment of maximum rpm</b>	Set the "High Speed" DIP switch to the ON position. Adjust "Max. rpm" so that the wheel rotates at 10-12 rpm (or as per directions from wheel manufacturer). After a test run, set the DIP switch to OFF.
<b>Checking minimum rpm</b>	Set the "Low Speed" DIP switch to ON. Check that the wheel starts. The minimum rpm is preset. After a test run, set the DIP switch to OFF.
<b>Checking the cleaning function</b>	Switch off the voltage. Make sure the "Cleaning function" DIP switch is set to ON and the input signal is disconnected. When power is switched on, the wheel will rotate at minimum rpm for 10 seconds.
<b>Checking the rotation monitor</b>	The yellow "Rotation" LED will flash when the magnet passes the magnetic sensor, regardless of DIP switch position.
<b>Finish by</b>	having the control unit drive the wheel at maximum and minimum rpm and checking that the wheel speed is correct.

## EMC INSTALLATION

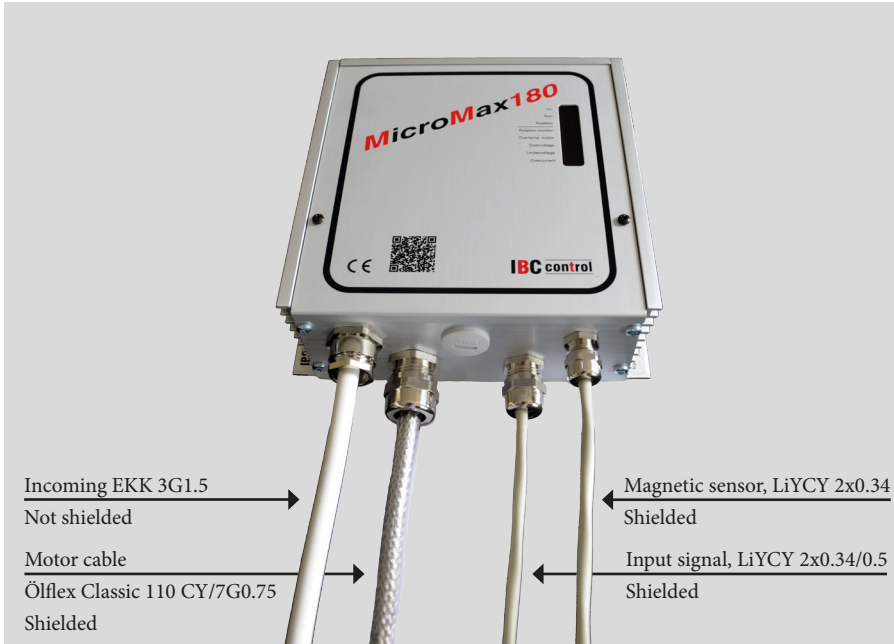

EMC glands must be used for shielded cables.

The above cables or equivalent must be used to comply with the EMC Directive.

## EMC GLAND

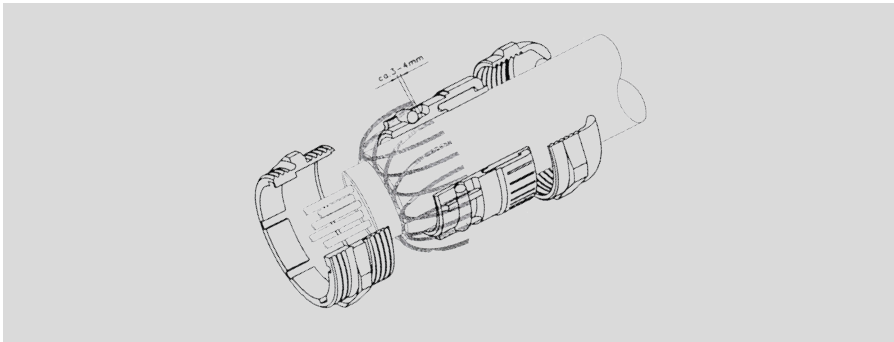

NOTE!

When connecting the shield to the EMC gland, it is important to do so as shown above.



## PERSONAL NOTES



F21018902GB  
Version 1.0.1  
2018-09-01

# **IBC**control

IBC control AB  
Brännerigatan 5 A  
SE-263 37 Höganäs  
Sweden  
Tel. +46 42 33 00 10  
[www.ibcccontrol.se](http://www.ibcccontrol.se)  
[info@ibcccontrol.se](mailto:info@ibcccontrol.se)