

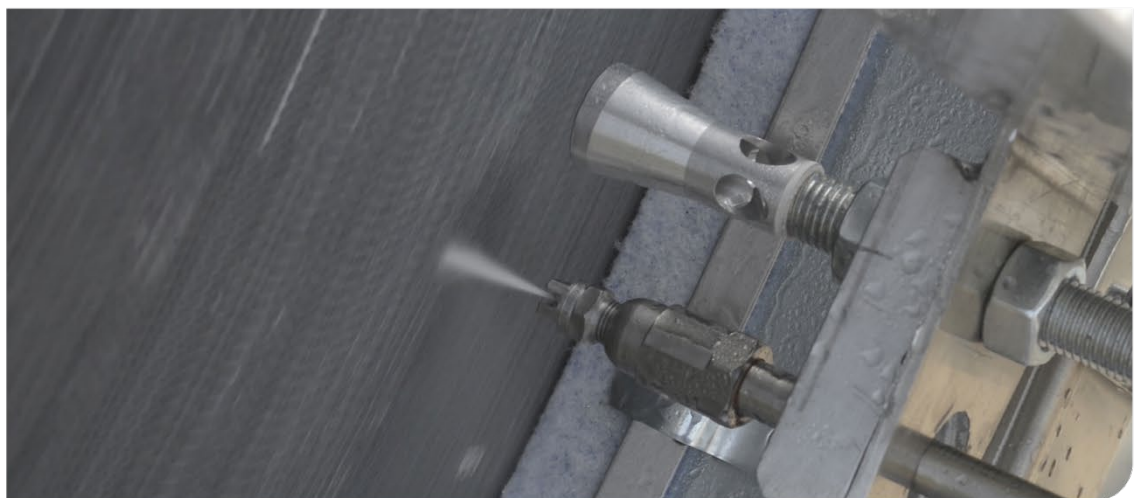

Rotor Cleaning Device Operating manual



Read this manual carefully before use!
Keep for future use!

Klingenburg GmbH

Brüsseler Straße 77

45968 Gladbeck

GERMANY

Telephone: +49 2043 96360

E-Mail: info@klingenburg.de

Internet: www.klingenburg.de

Original operating manual

Klin-64121-DE

© 2023 Klingenburg GmbH

Information about this manual

This manual enables safe and efficient handling of the machine. This manual is part of the machine and must be kept accessible to the staff (*Chapter 2.3 Personnel qualification on page 12*) at all times. The staff must carefully read and have understood this manual before starting any work on or with the machine. Basic requirement for safe working is compliance with all specified safety notices and instructions in this manual. In addition, the local accident prevention regulations and safety regulations for the area of application of the machine also apply.

Illustrations in this manual are for basic understanding and may differ from the actual design.

Applicable documents

In addition to this manual, the following documents must also be taken into account:

- Manual of the building management system
- Supplier documentation

Limitation of liability

All information and instructions in this manual were prepared taking into account the applicable standards and provisions, the state of the art and our many years of findings and experience.

The manufacturer accepts no responsibility for damage due to:

- Non-compliance with this manual
- Improper use
- Deployment of untrained personnel
- Unauthorised modifications
- Technical changes
- Use of unapproved spare parts

The actual scope of delivery may vary from the explanations and representations shown here in the event of special versions, the utilisation of additional ordering options or due to the latest technical changes.

The obligations agreed in the supply contract, the manufacturer's general terms and conditions and delivery conditions and the applicable legal regulations at the time the contract is concluded apply.

Copyright

Transferring this manual to third parties, reproducing it in any form – in whole or in part – and utilising and/or disclosing its content are not permitted without the express written consent of Klingenburg GmbH (referred to in the following as the "manufacturer"), except for internal purposes. Contraventions shall be subject to compensation for damages. The manufacturer reserves the right to assert further claims.

The manufacturer retains the copyright.

© Klingenburg GmbH 2023

Table of Contents

1.	Unpacking and checking scope of delivery	6
2.	Before you begin – safety	10
2.1.	Symbols in this manual.....	10
2.2.	Intended use.....	11
2.3.	Personnel qualification	12
2.4.	Personal protective equipment.....	14
2.5.	Working and danger areas	15
2.6.	Residual risks	15
2.6.1.	Electrical hazards.....	15
2.6.2.	Hazards from moving parts.....	16
2.6.3.	Tripping and slipping hazards	16
2.6.4.	Hazards from pressurised media	16
2.6.5.	Noise hazards	17
2.7.	Operator’s obligations.....	18
2.8.	Safety devices	19
2.9.	Securing against being switched on again	19
3.	Packing	20
4.	Technical specifications.....	21
4.1.	Cleaning rail.....	21
4.2.	Control units.....	22
4.3.	Stepper motor	25
4.4.	Media supply.....	26
4.4.1.	Compressed Air	26
4.4.2.	High pressure water	26
4.5.	Compressed air solenoid valve	27
4.6.	Sensors.....	29
5.	Layout and function.....	31
5.1.	Function layout	31
5.2.	Functional description.....	32
5.3.	Operating and display elements	33
5.4.	Sensors.....	34
5.5.	Connections.....	34
6.	Installation	38
6.1.	Safety instructions for the installation	38
6.2.	Mechanical installation	39
6.2.1.	Cleaning rail	39
6.2.2.	Drip pan.....	51
6.2.3.	Cleaning rail cover	53

6.2.4.	High-pressure water supply	54
6.2.5.	Compressed air supply	54
6.2.6.	Clock sensor	58
6.2.7.	Rotor cleaner control	60
6.2.8.	Rotor cleaner drive	62
6.3.	Electrical installation	63
6.3.1.	Rotor cleaner control	63
6.3.2.	Rotor cleaner drive	72
7.	Commissioning and operation	79
7.1.	Menu structure and menu navigation	79
7.2.	Basic settings and calibration	80
7.3.	Settings	84
7.3.1.	Open submenu "setup"	84
7.3.2.	Change language	86
7.3.3.	Set carriage step size	87
7.3.4.	Set maximum rotor speed	88
7.3.5.	Set minimum rotor speed	89
7.3.6.	Set length tolerance	90
7.3.7.	Set drying cycles	91
7.3.8.	Perform calibration	92
7.3.9.	Perform hardware test	93
7.4.	Scheduler	98
7.5.	Starting and stopping cleaning	101
7.6.	Status indicators	105
7.7.	Fault indications	109
8.	Maintenance	116
8.1.	Maintenance safety instructions	116
8.2.	Maintenance table	117
9.	Troubleshooting	118
10.	Disassembly and disposal	124

1. Unpacking and checking scope of delivery

Delivery

The rotor cleaning device is delivered with the full scope of delivery in packaging adapted to the transport route and delivery location.

Checking the delivery



Check delivery for transport damage and ensure it is complete immediately upon receipt. If it is incomplete or if there are defects, note the extent of the damage on the transport documents and lodge a complaint immediately.

Scope of delivery

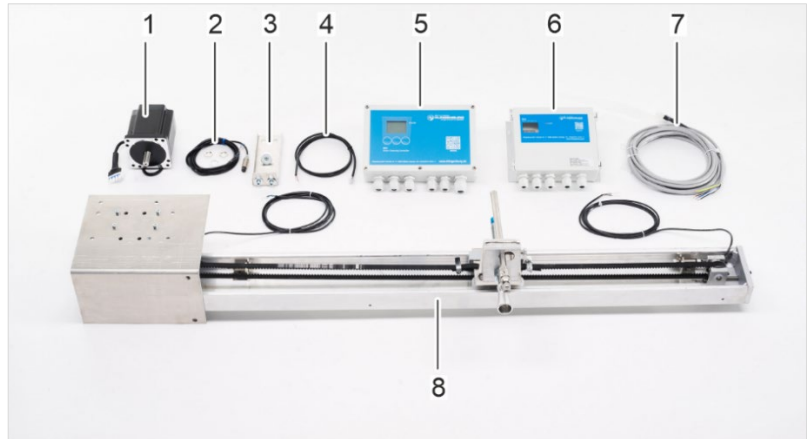

Fig. 1: Cleaning rail and accessories



Fig. 2: Deflection roller and toothed belt

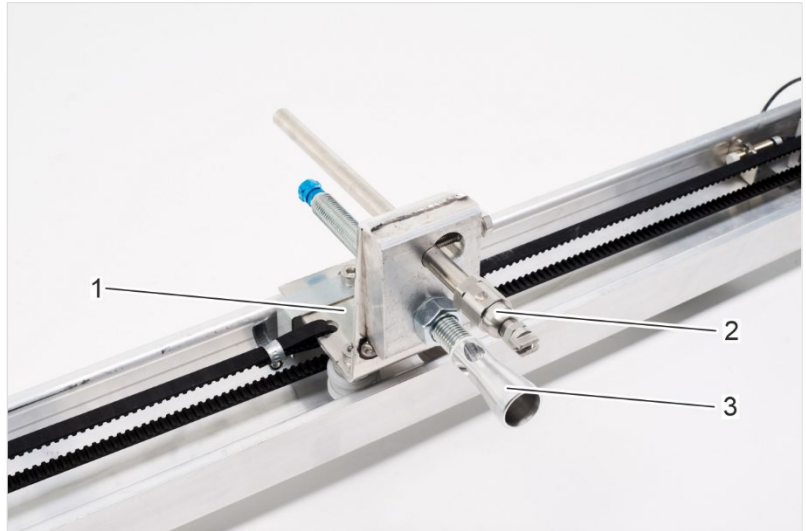

Fig. 3: Cleaning carriage with nozzles

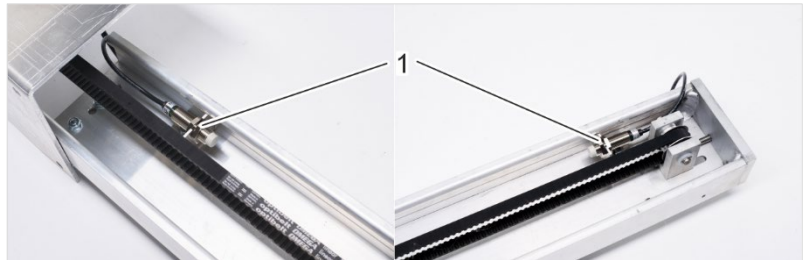

Fig. 4: Inductive proximity sensors



Fig. 5: Compressed air hose and 3/2-way compressed air solenoid valve



Fig. 6: Drip pan



Fig. 7: Cleaning rail cover

The scope of delivery includes:

- Pre-assembled cleaning rail (Fig. 1/8) with stepper motor (Fig. 1/1), two deflection rollers (Fig. 2/1), toothed belt (Fig. 2/2), cleaning carriage (Fig. 3/1) with high-pressure hot water nozzle (Fig. 3/2) and compressed air nozzle (Fig. 3/3) and two inductive proximity sensors (Fig. 4/1)
- Clock sensor (Fig. 1/2)
- Clock sensor holder with fasteners (Fig. 1/3)
- RS-485 modbus cable (Fig. 1/4)
- Cleaner Control (Fig. 1/5)
- Cleaner Drive (Fig. 1/6)
- Stepper motor cable with connector (Fig. 1/7)
- 3 m polyurethane compressed air hose (Fig. 5/1)
- 3/2-way solenoid valve (Fig. 5/2)
- Drip pan (Fig. 6)
- Cleaning rail cover (Fig. 7)

Optional:

- Cross beam for cleaning rail mount

Handling packaging material

The individual packages are packed according to the expected transport conditions.

The packaging provides protection against transport damage, corrosion and other damage. For this reason, do not destroy the packaging and do not remove it until shortly before use.

Dispose of packaging material in accordance with the applicable statutory provisions and local regulations.



ENVIRONMENT!

Danger to the environment due to incorrect disposal!

Packaging materials are valuable raw materials and can, in many cases, be further utilised or appropriately reconditioned and recycled. Incorrect disposal of packaging materials can be hazardous to the environment.

- Dispose of packaging materials in an environmentally sound manner.
- Observe the locally applicable disposal regulations. If necessary, engage the services of a specialist company with regard to disposal.

Storage

Store packages under the following conditions:

- Do not store outdoors.
- Store in a dry and dust-free place.
- Do not expose to aggressive media.
- Protect from sun exposure.
- Avoid mechanical shocks.
- If stored for more than 3 months, regularly check the general condition of all parts and the packaging.



There may be storage instructions on the packages that go beyond the requirements mentioned here. Comply with these accordingly.

2. Before you begin – safety

This chapter provides an overview of all important safety aspects for protecting personnel and for ensuring safe and fault-free operation. Further task-specific safety instructions can be found in the sections of the individual chapters.

2.1. Symbols in this manual

Safety instructions

Safety instructions are indicated by symbols in this manual. The safety instructions are introduced by signal words that indicate the degree of danger.



DANGER!

This combination of symbol and signal word indicates an imminently dangerous situation which, if not avoided, will result in death or serious injury.



WARNING!

This combination of symbol and signal word indicates a potentially dangerous situation which, if not avoided, could result in death or serious injury.



CAUTION!

This combination of symbol and signal word indicates a potentially dangerous situation which, if not avoided, could result in slight or minor injuries.



NOTICE!

This combination of symbol and signal word indicates a potentially dangerous situation which, if not avoided, could result in damage to property.



ENVIRONMENT!

This combination of symbol and signal word indicates potential dangers to the environment.

Safety instructions in specific instructions

Safety instructions may refer to specific, individual instructions. Such safety instructions are integrated into the instruction so that they do not interrupt the flow of reading when carrying out the task. The signal words described above are used.

Example:

1. Loosen the screw.
- 2.



CAUTION!
Risk of pinching by cover!

Close the cover carefully.

3. Tighten the screw.

Tips and recommendations



This symbol highlights useful tips and recommendations as well as information designed to ensure efficient and smooth operation.

Other markings

The following markings are used in this manual in order to highlight instructions, outcomes, lists, references and other elements:

Marking	Explanation
⇒	Outcomes of steps
↗	Reference to sections of this manual and to other applicable documents
■	Lists without fixed order
[Button]	Controls (e.g. buttons, switches), indicators (e.g. signal lamps)
„Display“	Display elements (e.g. on-screen ads)
„Menu“ → „Submenu“ → „Setting“	Shortened description of navigation: Call up menu, call up submenu, change settings

2.2. Intended use

Intended Use

The rotor cleaning device is used to clean the storage mass of rotary heat exchangers and is intended exclusively for installation in rotary heat exchangers of the Klingenburg RRS and RRT series.

The machine must be integrated into the safety concept of the building management system at the place of use.

Intended use also includes compliance with all information in this manual.

Misuse

Any use that deviates from the intended use, in particular use on machines other than rotary heat exchangers of the Klingenburg RRS and RRT series and use in potentially explosive environments is misuse.



WARNING!

Danger from misuse!

Misuse of the machine can lead to serious injuries or even death.

- Only operate the machine after it has been integrated into the building management system at the place of use and the required safety devices have been installed. The safety devices are to be designed and installed by the operator.
- Only use the machine as intended.
- Strictly comply with all information in this manual.
- Do not operate the machine without first calibrating it.
- Only operate the machine on rotary heat exchangers from the Klingenburg RRS and RRT series.
- Never operate the machine in an explosive environment.
- Do not rebuild, convert or change the design of the machine with the aim of changing the area of application.
- Refrain from converting or changing the construction or individual pieces of equipment with the aim of changing the area of application or the usability.
- Do not operate the machine outside the range of the technical specifications.

Claims of any kind for damage due to misuse are excluded.

The operator alone is liable for any damage caused by improper use.

2.3. Personnel qualification

Risk of injury for unqualified personnel and unauthorized persons



WARNING!

Risk of injury for unqualified personnel and unauthorized persons!

Persons who do not meet the personnel qualifications listed in this section do not know the dangers of the individual work and danger areas → *Chapter 2.5 Working and danger areas on page 15*. If personnel without the required qualifications perform work on or with the rotor cleaning device or if such persons are present in the danger zone while work is being performed, dangers arise that could cause serious injuries and considerable property damage.

- Have all tasks performed by suitable qualified personnel without exception.
- Keep unqualified personnel away from the danger zones and work areas.

List of personnel qualifications

The qualifications of the personnel required to carry out the activities on the machine are defined below.

The definition of personnel qualifications depends on their main focus. A distinction is made here between the personnel who operates the machine (user), the personnel who prepares the machine for operation (service technician, electrician) and the operator, who bears the legal product responsibility for the protection of personnel or third parties.

User:

The user has been verifiably trained by the operator to handle the machine and is aware of the potential risks associated with improper use.

The user performs the following tasks on the machine:

- Manually starting and stopping the cleaning process
- Setting the cleaning parameters

Service technician:

The service technician is able to work on industrial machinery because of his technical training, knowledge and experience and knowledge of the relevant standards and regulations.

The service technician is specially trained for his working environment and is aware of the relevant standards and regulations.

He has been demonstrably instructed by the operator to handle the machine.

In addition to the work performed by the user, the service technician may perform the following tasks:

- Assembly work
- Complex set-up work
- Complex maintenance work
- Complex troubleshooting tasks

Electrician:

Due to his training, knowledge, experience and knowledge of the relevant standards and provisions, the electrician is able to carry out the following work on electrical systems professionally and safely:

- Planning and connecting electrical systems on the basis of circuits and circuit diagrams
- Assembling cables and connecting electrical components
- Analysing, measuring and testing electrical systems and functions
- Carrying out safety checks on electrical systems, components and devices
- Analysing and troubleshooting electrical systems

Operator:

The operator is a natural or legal person who operates the rotor cleaning device for commercial or economic purposes themselves, or makes it available for a third-party to use, and who bears the legal responsibility for the product vis-à-vis protection of personnel and third parties during operation.

2.4. Personal protective equipment

Personal protective equipment protects people from impairments of safety and health at work.



The operator must identify the specific hazards at the site and prescribe the appropriate protective equipment. Unless otherwise prescribed by the operator, wear the protective equipment specified in this chapter.

The staff must wear personal protective equipment during the various works on and with the machine, referred to separately in the individual sections of this manual.

Description of personal protective equipment

The different types of personal protective equipment are detailed below:



Protective clothing

Protective work clothing is close-fitting work clothing with low tear resistance, tight sleeves and no protruding parts.



Safety shoes

Safety shoes protect feet from bruises, falling parts and slipping on slippery surfaces.



Protective gloves

Protective gloves protect hands from friction, abrasions, punctures or deeper injuries and from touching hot surfaces.

2.5. Working and danger areas

During normal operation, it is not necessary for personnel to be in the area of the rotor cleaning device. Personnel only needs to be in the area of the rotor cleaning device for adjustment and maintenance work and for troubleshooting. In this case, the areas of the rotor cleaning device and the cleaner control are regarded as workspace. The exit area of the compressed air nozzle and the high-pressure warm water nozzle as well as the inside of the cleaning rail are regarded as danger areas.

2.6. Residual risks

2.6.1. Electrical hazards

Electrical voltage



DANGER!

Risk of fatal injury from electric current!

In case of contact with live parts, there is a risk of fatal injury through electric shock.

- Only qualified electricians may work on electrical components.
- Before doing any work on the electrical system, switch it off and secure it against being switched on again.
- Even after the electrical system has been switched off, dangerous electrical voltage is still present on internal circuit components. Wait at least 5 minutes for the residual voltage to dissipate before working on electrical components.
- Check that there is no voltage before any intervention.
- In case of damage to the insulation switch off power supply immediately and arrange for repairs.
- Keep away moisture from live components.

Circuit protection



DANGER!

Risk of electric shock due to insufficiently secured circuits!

In the case of incorrectly secured circuits unintentional currents may flow and cause serious injury or death.

- Only operate the electrical system with proper grounding.
- Never take fuses out of service or bypass them.

2.6.2. Hazards from moving parts

Cleaning carriage



WARNING!

Danger of being crushed and drawn in by the cleaning carriage!

Body parts can be crushed or hair and limbs pulled in on the cleaning carriage.

- Do not reach into the cleaning carriage when it is running.
- Only operate the cleaning carriage with mounted lid.
- Before carrying out any work on the cleaning carriage, switch off the machine and secure it against being switched on again.

2.6.3. Tripping and slipping hazards

Power cords and supply lines



CAUTION!

Tripping hazard from power cords and compressed air and water supply lines!

There is a risk of tripping if the power cables and supply lines are not laid properly.

- Lay power cables and supply lines in such a way that tripping hazards are avoided.

Fluid accumulations



CAUTION!

Danger of slipping due to accumulation of liquid!

Fluid buildup increases the risk of slipping and falling.

- Clean up any accumulations of liquid immediately.
- Fix any leaks.
- Check the position of the drip pan and adjust if necessary.

2.6.4. Hazards from pressurised media

Pressurised water



WARNING!

Risk of injury from water spraying out!

If there is a leak in the high-pressure hot water line, water can spray out under high pressure and cause injury.

- Wear protective goggles when working near the line connections.
- In the event of leaks, switch off the Rotor Cleaning Device and repair the damage.
- Do not reach into the liquid jet.

Pressurised supply lines



WARNING!

Risk of injury from pressurised supply lines!

During and after operation, the compressed air and water lines are under pressure. Working on pressurised components can lead to serious injuries.

- Prior to any work on the compressed air and water lines, depressurise them.

High pressure jets



WARNING!

Risk of injury from compressed air and water escaping at high pressure from the nozzles!

Compressed air and water escaping at high pressure from the nozzles of the cleaning carriage during the cleaning process can lead to serious injuries.

- Do not reach into the compressed air or water jet.
- Wear protective goggles when working near the nozzles.
- Before doing any work on the nozzles, switch off the machine and secure it against being switched on again and disconnect it from the media supply.

2.6.5. Noise hazards

Compressed air and water escaping under high pressure and high speed



WARNING!

Risk of injury from noise!

The noise level caused by the compressed air and water escaping from the nozzles at high pressure and velocity can cause serious hearing damage.

- Stay in the danger area only for as long as necessary.
- Wear hearing protection in the danger area during the cleaning process.

2.7. Operator's obligations

The rotor cleaning device is used in the commercial sector. The operator of the rotor cleaning device is therefore subject to the statutory obligations pertaining to occupational safety.

In addition to the safety instructions in this manual, the applicable safety, occupational safety and environmental protection regulations for the rotor cleaning device's area of application must be adhered to.

The following specifically applies in this regard:

- Operators must familiarise themselves with the applicable occupational safety regulations and, as part of a risk assessment, determine additional dangers that arise as a result of the specific operating conditions at the operating site of the rotor cleaning device. This risk assessment must be implemented in the form of safety instructions for operation of the rotor cleaning device.
- During the entire time the rotor cleaning device is in use, the operator must check whether the safety instructions reflect current regulations and, if necessary, the operator must change the instructions accordingly.
- The operator must clearly define and regulate responsibilities for all work on and with the rotor cleaning device. The authority and responsibilities of personnel regarding installation, operation, troubleshooting, maintenance and cleaning must be clearly defined.
- The operator must ensure that all persons handling the machine have read and understood these instructions. In addition, he must train the staff at regular intervals and inform them about the dangers.
- The operator must provide the personnel with the necessary protective equipment and must instruct them to wear the necessary protective equipment.

Furthermore, the operator is responsible for ensuring that the rotor cleaning device is always in perfect technical condition. Therefore the following applies:

- The operator must ensure that the maintenance intervals described in this manual are observed.
- The operator must have all safety devices checked regularly for functionality and completeness.
- The operator must install emergency stop devices for the rotor cleaning device and integrate them into the safety chain of the higher-level control.

2.8. Safety devices

Location of safety devices

The machine does not have its own safety devices. The operator must install emergency stop devices for the rotor cleaning device and integrate them into the safety chain of the higher-level control.

Integration in an emergency stop concept

The rotor cleaning device is intended for attachment to rotary heat exchangers that are controlled via a higher-level control system at their respective place of use. The rotor cleaning device does not have an autonomous emergency stop function.

Before commissioning, install an emergency stop device for the rotor cleaning device and integrate it into the safety concept of the higher-level control system.

Connect the emergency stop device in such a way that in the event of an interruption of the power supply or the activation of the power supply after an interruption, dangerous situations for people and property are excluded.

The emergency stop devices must always be freely accessible.

2.9. Securing against being switched on again



WARNING!

Risk of fatal injury from unauthorised restarting!

If the power supply is switched on again without authorisation during maintenance or troubleshooting, there is a risk of serious or fatal injury for persons in the danger zone.

- Before starting any maintenance work or troubleshooting work, switch off the power supply to the machine and secure it against being switched on again  *Operating manual for the building control system.*

3. Packing

Packaging unit cleaning rail



Fig. 8: Cleaning rail packing

The cleaning rail is delivered packed in bubble wrap. The bubble wrap serves to protect the cleaning rail and the components preassembled on it from damage during transport. A red tape on the bubble wrap warns about highly sensitive electronic equipment.

Packaging unit accessories



Fig. 9: Accessories packing

The remaining delivery components, such as the cleaner control, cleaner drive etc., are delivered packed in a cardboard box. A red tape on the cardboard box warns about highly sensitive electronic equipment. On the carton are the following instructions for safe handling of the packages.

Fragile



Marks packages with fragile or sensitive content.

Handle the package with care, do not drop it and do not subject it to shocks.

Top



The arrowheads of the mark indicate the top of the package. They must always point upwards, otherwise the contents could be damaged.

Protect from moisture



Protect packages from moisture and keep them dry.

4. Technical specifications

4.1. Cleaning rail

Weight	<p>The weight of the cleaning rail depends on the size of the rotary heat exchanger to which the respective cleaning rail is attached.</p> <p>9.53 kg at 720 mm minimum size of the cleaning rail (design for the smallest available Klingenburg rotary heat exchanger).</p> <p>The weight increases by 0.66 kg for every 100 mm of additional length.</p>
Length	<p>The length of the cleaning rail depends on the size of the rotary heat exchanger to which the respective cleaning rail is attached.</p> <p>The minimum length is 720 mm (design for the smallest available Klingenburg rotary heat exchanger).</p>

4.2. Control units

Rotor Cleaner Control

Supply voltage	230 V AC \pm 10% @ 50/60 Hz
Power consumption	0.5 W @ 230 V AC
Ambient air humidity	10-95 %RH, non-condensing
Fuse	Internal T800 mA, external 16 A
Classification	Class II
Modbus internal	38,400 baud, 8 data bits, 2 stop bits, no parity
Modbus external	setup in menu
Relay	8A AC1, 3A AC3, 0-230 V AC
Ambient temperature	
Display	0°C - 50°C
Constant operation	-30°C - 50°C
Storage	-40°C - 70°C
Enclosure rating	IP 54
Housing dimensions [hxwxh]	175 x 223 x 55 mm
Cable gland	
M12 x 3	\varnothing 2.5 - 6.5 mm
M16 x 2	\varnothing 4.0 - 9.5 mm
M20 x 1	\varnothing 5.5 - 12.0 mm
Weight	800 g



At temperatures below 0°C, the display can be expected to progressively lose intensity. The display may also be slower to update.

Rotor Cleaner Drive

Torque	4.0 / 8.0 Nm *
Power Size	220 W
Efficiency	> 90%
Power supply	
Voltage	1 x 230 V AC 50/60 Hz \pm 10%
Supply current at max. load	2.4 A
Power factor (cos-phi) at max. load	0.65
Motor output	
Nominal motor power	110 / 220 W *
Motor speed	0 - 400 rpm
Nominal motor torque	4.0 / 8.0 Nm *
Boost motor torque	5.0 / 10.0 Nm *
Frequency	0 - 120 Hz
Max. output voltage	3 x 0 - 200 V AC Vrms
Max. output current	3.5 Arms
Protection	
Max. fuse	10 A
Motor output	Short-circuit protected between phases
Motor	Protected by current limit
Impulse protection	Transient protected by VDR
Overvoltage protection	No
Overload protection	Current and temperature overload protection
Ambient temperature	
Operating temperature	-40°C to +40°C
Starting temperature	-40°C to +40°C
Storage temperature	-40°C to +70°C
Dimensions [hwxwd]	143 x 183 x 55 mm

Protection rating	IP 54
Enclosure material	Plastic
Front cover	Plastic
Weight	900 g
Humidity	10-95% rh, non-condensing
Cooling	Self-cooling
Interfaces	
Modbus RTU interface protocol	(Baud rate: 9.6, 19.2, 38.4, 57.6, 115.2 kBaud) Default: 38.4 kBaud, 1 stop bit, non-parity
RS-485 interface connection	2 x RJ12 & 3 x spring terminals
RS-485 interface cable	Max. 100 m
BACnet MS/TP	Baud rate: 9600, 19200, 38400, 57600, 115200 kbs MAC: 0 - 127, MAX Master 1 - 127 Device object ID: 0 - 4194302
7-segment display	3
Analogue In1	0-10 VDC, 100% at 9.5 VDC \pm 2%
Analogue Out1	+10 VDC
Digital In3 (internal Pull up)	External rotor guard
Digital Out1	No
Alarm relay	SPDT relay 1A 30 VDC / 24 VAC
Green LED	On: Power connected Flashing: Active RS-485 interface communication
Red LED	Constant On: Serious alarm - stop motor. Flashing: Alarm but keep running
DIP switches	4

Functions	
Technology	Sinusoidal back-EMF signal controlled via FOC (field-oriented control)
Alarm	Yes
Alarm reset	Via rotor cleaner control
Service data log	Operating hours, alarms, loads, software version, max. temperature, max. motor voltage, max. motor current, max. ripple voltage, max. ripple current
Software updating	Yes, via serial interface
Short-circuit protection	Yes
EMC filter	Integrated

* depending on the connected motor

4.3. Stepper motor

Torque	4.0 Nm
Power Size	110 W
Weight	rd. 3.5 kg
International protection class	IP 54
Operating temperature	-40°C to +45°C
Storage temperature	-40°C to + 70°C
Dimensions [h x w x d]	85 x 85 x 97 mm
Shaft diameter	12 mm
Cable length (with connector)	0.3 m
Max. radial force (20 mm from the flange)	250 N
Max. axial force	60 N

4.4. Media supply

4.4.1. Compressed Air

Compressed air supply

Operating pressure	6 – 8 bar
--------------------	-----------

4.4.2. High pressure water

High pressure water supply

Water pressure	60 bar
----------------	--------

Temperature	Max. 50 °C
-------------	------------

4.5. Compressed air solenoid valve

3/2-way compressed air solenoid valve

Valve function	3/2-way, closed, monostable
Type of actuation	Electric
Valve size	21mm
Standard nominal flow	700 l/min
Pneumatic working port	G1/8
Operating pressure	0.25MPa – 1 MPa
Operating pressure	2.5 bar – 10 bar
Design	Piston gate valve
Type of reset	Mechanical spring
Approval	c UL us - recognised (OL)
Nominal size	5.7 mm
Exhaust air-function	With flow control option
Sealing principle	Soft
Mounting position	Optional
Manual override	Detenting Non-detenting
Type of piloting	Pilot-actuated
Pilot air supply	Internal
Flow direction	Non-reversible
Operating medium	Compressed air to ISO 8573-1:2010 [7:4:4]
Note on operating and pilot medium	Lubricated operation possible (in which case lubricated operation will always be required)
Vibration resistance	Transport application test with severity level 2 to FN 942017-4 and EN 60068-2-6
Shock resistance	Shock test with severity level 2 to FN 942017-5 and EN 60068-2-27

Corrosion resistance class CRC	2 - Moderate corrosion stress
LABS (PWIS) conformity	VDMA24364-B1/B2-L
Media temperature	-10 °C – 60 °C
Pilot medium	Compressed air to ISO 8573-1:2010 [7:4:4]
Ambient temperature	-10 °C – 60 °C
Product weight	136 g
Type of mounting	Either: On terminal strip With through-hole
Breather connection	Not ducted
Pilot exhaust port 82	M5
Pneumatic connection, port 1	G1/8
Pneumatic connection, port 2	G1/8
Pneumatic connectino, port 3	G1/8
Note on materials	RoHS-compliant
Material seals	HNBR NBR
Materials housing	Die-cast aluminium Painted
Material piston slide	Wrought aluminium alloy
Material screws	Galvanised steel

4.6. Sensors

Inductive proximity sensor AM1/CP-2A

Electrical data	
Supply voltage	10 - 30 VDC
Idle current	10 mA
Load current	200 mA
Leakage current	10 µA
Output voltage drop	1.8 V at 200 mA
Switching frequency	2 kHz
Nominal sensing distance	4 mm
Operating distance	0 - 3.2 mm
Short circuit protection	Yes
Reverse polarity protection	Yes
Protection against inductive loads	Yes
Outputs	
Output type	PNP
Output function	NC
Yellow LED	On: Output active
Mechanical Data	
Dimensions	M12 x 50
Weight	70 g
Cable length	2 m
Mounting	Unshielded
Housing	Nickel-plated brass
Active head material	PBT
Tightenin torque	10 Nm
Environment	
Operating temperature	-25°C to +70°C

Clock Sensor E2E-X8MC1122M

Size	M12
Mounting type	Non-flush
Sensing distance	8 mm
Overall length	47.1 mm
Thread length	26 mm
Material housing	Brass, nickel-plated
Output type	NPN
Operation Mode	NO
Poles	3
Connection method	Cable
Cable specifications	PVC (oil-resistant)
Cable length	2 m
Protection rating	IP67/IP67G/IP69K

5. Layout and function

5.1. Function layout

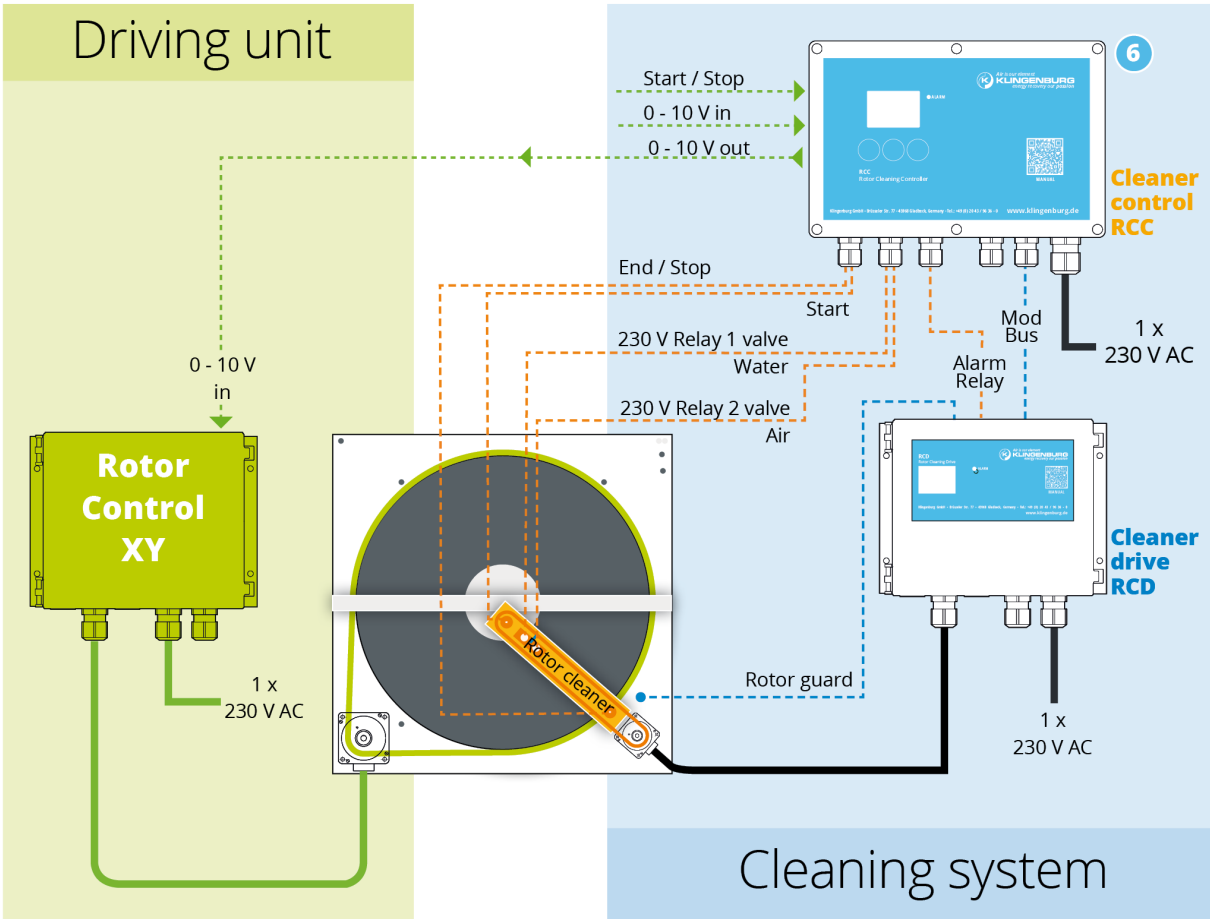

Fig. 10: Function layout of the rotor cleaning device

5.2. Functional description

The rotor Cleaning device is used to clean the rotor matrix or rotary heat exchangers of the Klingenburg RRS and RRT series, which are exposed to polluted exhaust air during operation.

The cleaning prevents the rotor matrix from becoming clogged, e.g. by sticky or greasy exhaust air components, and thus prevents reduced performance or even failure of the rotary heat exchanger.

The rotor cleaning device has two control units: The cleaner control for controlling and monitoring the cleaning process and for adjusting the rotor speed and the cleaner drive for controlling the drive of the cleaning carriage depending on the rotor speed and the set cleaning parameters. Depending on the air pollution to be expected at the place of use, the rotor cleaning device is either equipped with just a compressed air nozzle or with a compressed air nozzle and a high-pressure hot water nozzle. The cleaning nozzles are mounted on a cleaning carriage inside the cleaning rail which can be moved across the radius of the rotor. The compressed air and water are switched on and off via two solenoid valves which are switched by the cleaner control depending on the position of the cleaning carriage. The end positions of the rotor centre and rotor circumference of the cleaning carriage are detected by two inductive proximity sensors installed in the cleaning rail. The cleaning carriage is moved by a toothed belt driven by a stepper motor. The stepper motor is controlled by the Cleaner Drive depending on the process. A clock sensor installed in the rotor housing records the revolutions of the rotor.

The cleaning process can either be started manually using a start button on the Cleaner Control, using an external switch contact or using a timer integrated in the Cleaner Control. After the start command has been given, the cleaning carriage initially moves to the centre of the rotor without media. An inductive proximity sensor confirms that the cleaning carriage has reached the centre of the rotor and sends a signal to the Cleaner Control. The Cleaner Control then switches on the compressed air and water (optional) supply via the solenoid valves. The clock sensor records the revolutions of the rotor and sends this signal to the Cleaner Drive. After each revolution of the rotor, the Cleaner Drive moves the cleaning carriage by a preset distance. This process is repeated until the cleaning carriage has reached the circumference of the rotor. The proximity sensor on the circumference of the rotor sends a signal to the Cleaner Control as soon as the cleaning carriage has reached the circumference of the rotor. The Cleaner Control then switches off the water supply and the cleaning carriage moves back to the centre of the rotor with the compressed air still switched on. When the cleaning carriage has reached the centre of the rotor, the proximity sensor in the centre of the rotor sends a signal to the Cleaner Control, which then switches off the compressed air supply. The cleaning carriage then moves back to its parking position on the rotor circumference. The cleaning process is complete.

5.3. Operating and display elements

Rotor Cleaner Control

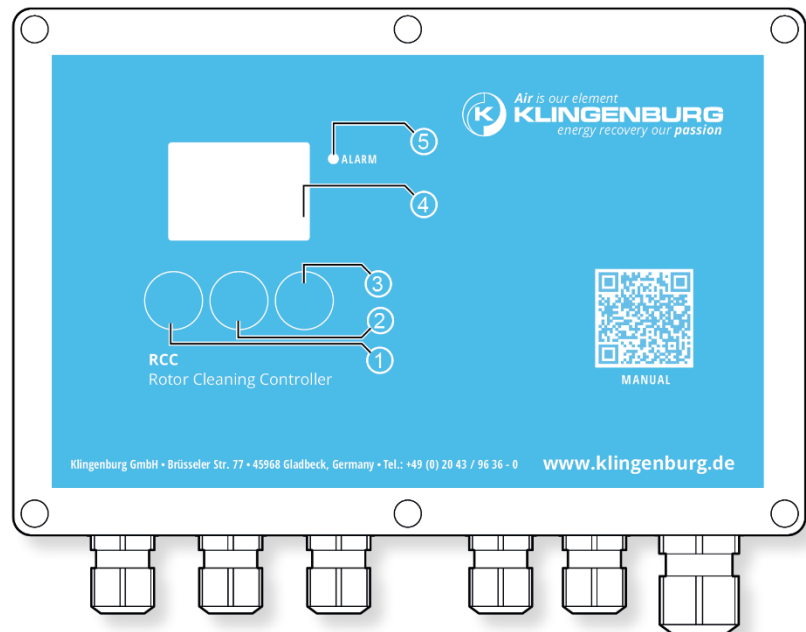

Fig. 11: Rotor cleaner control operating and display elements

- 1 Start / Cancel / Up / Down / Left / Back
- 2 OK / Menu / Up
- 3 Up / Down / Calib / Right
- 4 Display
- 5 Red alarm LED



The function of the buttons (Fig. 11/1, Fig. 11/2 and Fig. 11/3) depends on the menu that is currently called up.

5.4. Sensors

Inductive proximity sensors

The inductive proximity sensors are used to monitor the end position (centre and circumference of the rotor) of the cleaning carriage. On the one hand, they prevent the cleaning carriage from colliding with the rotor housing, and on the other hand, the compressed air and high-pressure water supply are switched on or off via their signals.

The sensors are mounted in the cleaning rail. They are threaded along their entire length. This allows the position of the sensors to be adjusted during assembly.

Clock sensor

The clock sensor is used to record the rotor revolutions. The feed of the cleaning carriage is controlled via the signal from the clock sensor and the set carriage step size.

5.5. Connections

Rotor Cleaner Control port openings

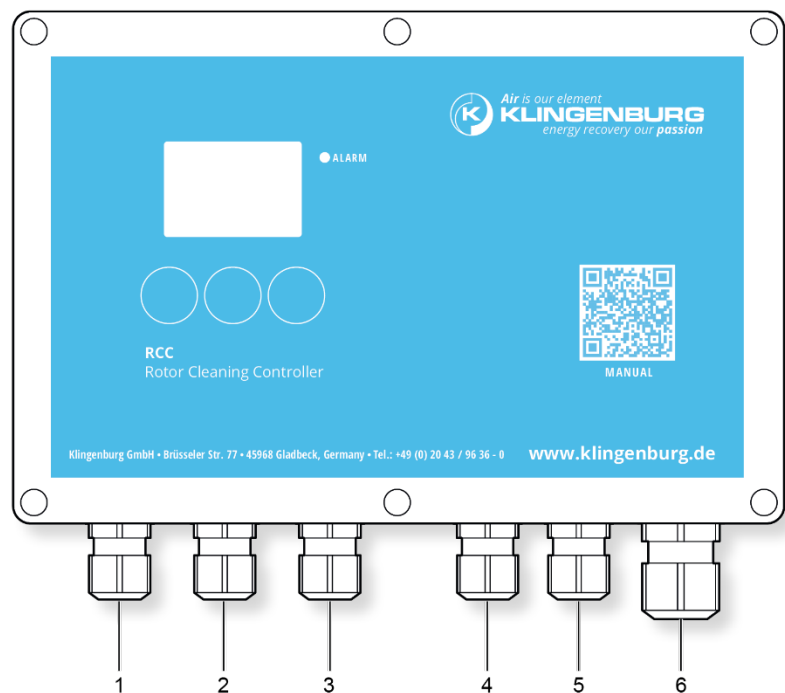

Fig. 12: Rotor cleaner control port openings

- 1 External Modbus / Internal Modbus
- 2 Inductive proximity Sensors for rotor centre and rotor circumference
- 3 External Start / External rotor speed control signal in/out
- 4 Water relay
- 5 Compressed air relay
- 6 Power supply 230 V AC

Rotor Cleaner control terminal assignment

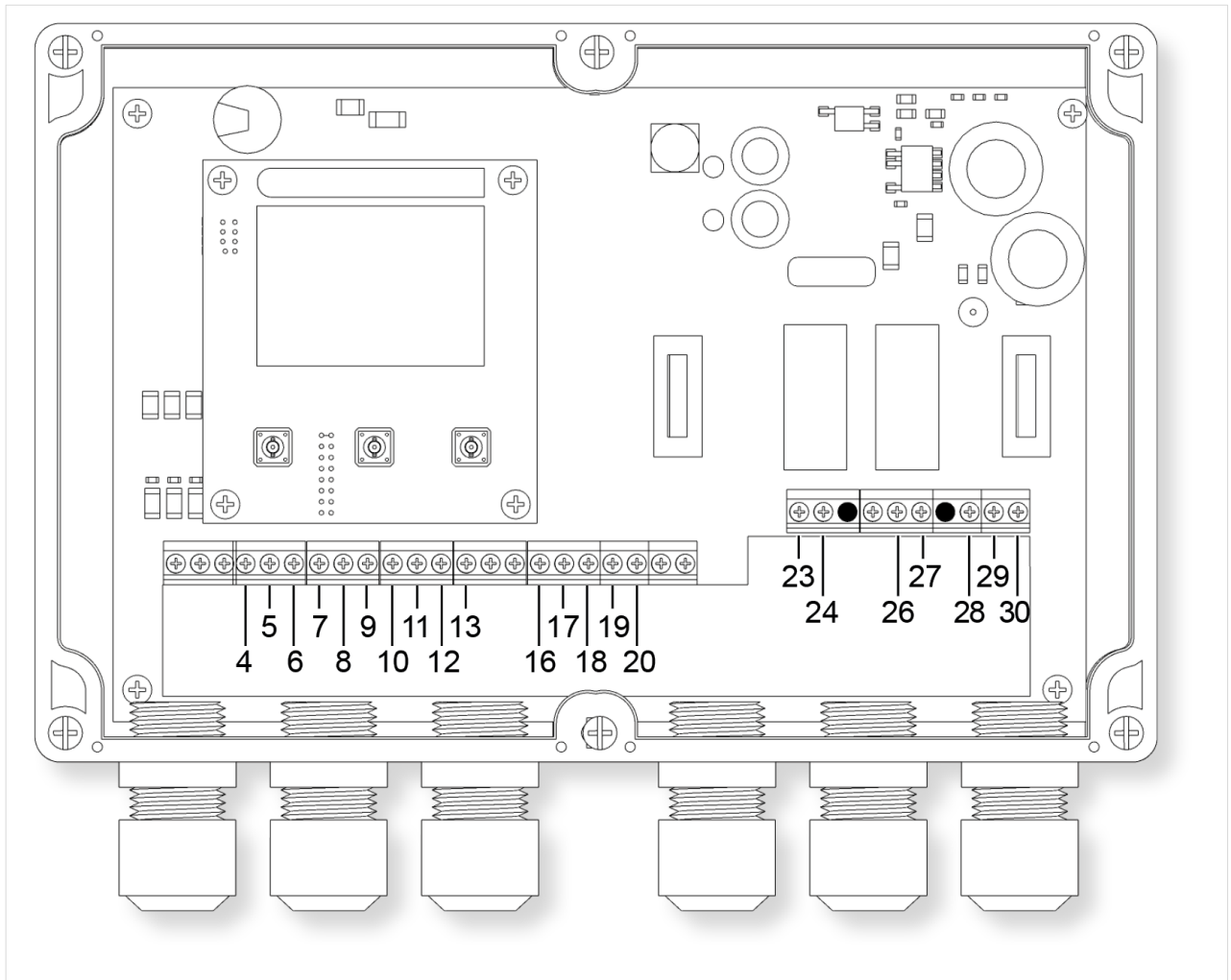

Fig. 13: Rotor cleaner control terminal assignment

- 4 +24 V DC power supply inductive proximity sensor rotor circumference
- 5 Modbus signal line A
- 6 Modbus signal line B
- 7 Modbus ground connection
- 8 Signal line inductive proximity sensor rotor circumference
- 9 Inductive proximity sensor rotor circumference ground connection
- 10 Inductive proximity sensor rotor centre signal line
- 11 Inductive proximity sensor rotor centre ground connection
- 12 External start signal line
- 13 External start ground connection
- 17 +24 V DC power supply inductive proximity sensor rotor centre
- 17 external rotor speed control signal 0 – 10 V input
- 18 external rotor speed control signal ground connection
- 19 Rotor speed control signal 0 – 10 V output
- 20 Rotor speed control signal ground connection
- 23 Water relay ground connection
- 24 +230 V AC power supply
- 26 Air relay ground connection
- 27 +230 V AC power supply
- 28 Phase conductor
- 29 Neutral conductor
- 30 Protective conductor

Rotor Cleaner Drive port openings



- 1 Modbus
- 2 Alarm
- 3 Clock sensor
- 4 Power supply
- 5 Stepper motor

Rotor Cleaner Drive terminal assignment

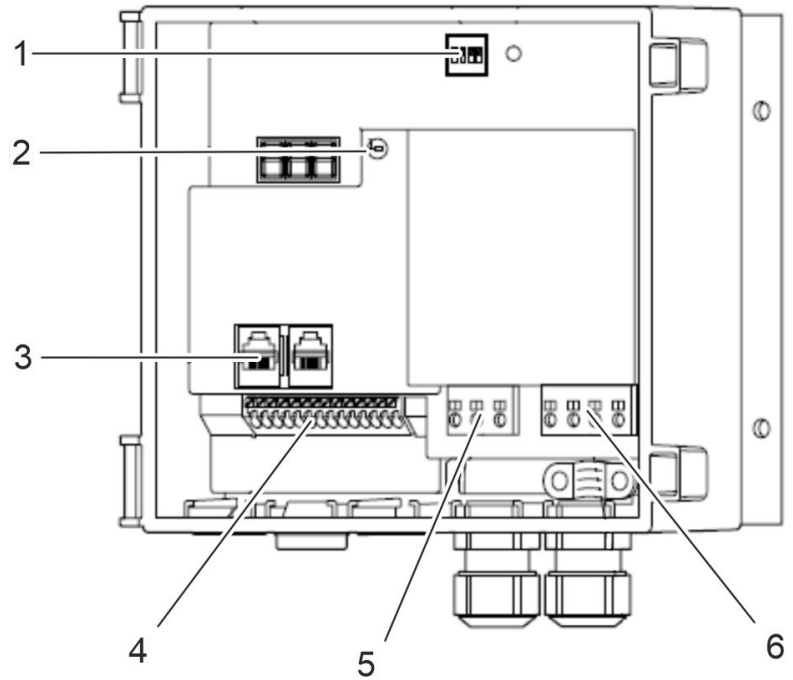

Fig. 14: Rotor cleaner drive terminal assignment

- 1 4-pole DIP switch
- 2 LED
- 3 RJ12 RS-485 interface connector (2 x RJ12)
- 4 A/D control and signal terminals
- 5 Power supply terminals (L, N, PE)
- 6 Connection terminals for stepper motor (U, V, W, PE)

6. Installation

6.1. Safety instructions for the installation

Electrical System



Danger!

Risk of fatal injury from electric current!

In case of contact with live parts, there is a risk of fatal injury through electric shock.

- Before starting work, switch off the electrical supply and secure it against being switched on again.
- Work on the electrical system should only be carried out by qualified electricians

Unauthorised or uncontrolled switching on



Warning!

Risk of serious or fatal injury due to unauthorised or uncontrolled switching on again!

Unauthorised or uncontrolled switching on again can cause serious or even fatal injuries.

- Before switching on again, make sure that there is no danger to persons.
- Always follow the building management system's procedure for protecting against switching back on and switching back on.

Improper installation



Warning!

Risk of serious or fatal injury due to improper installation!

Improper installation can result in serious personal injury or even death and significant property damage.

- Before starting work, ensure that there is sufficient space for assembly.
- Be careful with exposed, sharp-edged components.
- Ensure order and cleanliness at the assembly site! Components and tools lying loosely around or on top of each other are sources of accidents.
- Install components professionally. Observe the prescribed screw tightening torques.
- Secure components to prevent them from falling or tipping over.
- Observe all installation information in this manual.

6.2. Mechanical installation

6.2.1. Cleaning rail



The possible position of the cleaning rail on the frame of the rotary heat exchanger depends on the arrangement of the air flow separation.

Horizontal air flow separation

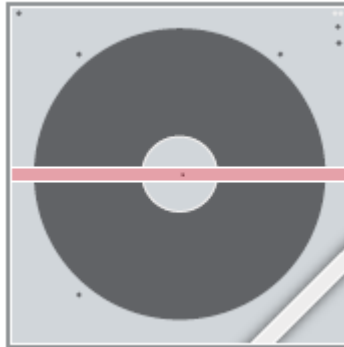

Fig. 15: Horizontal air flow separation

Possible positioning of the cleaning rail with horizontal air flow separation

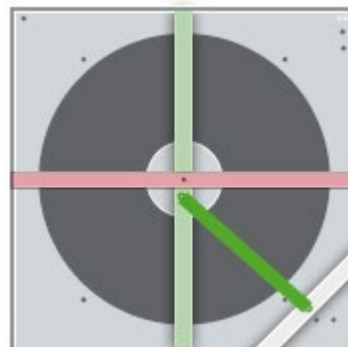

Fig. 16: Possible positioning of the cleaning rail

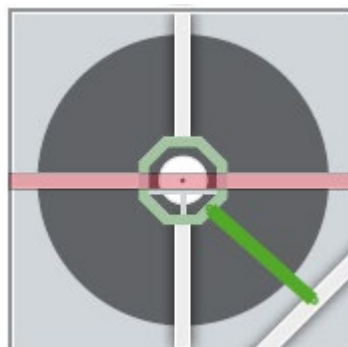



Fig. 17: Possible positioning of the cleaning rail

-  Unavailable area for attaching the cleaning rail
-  Available area for attaching the cleaning rail

Vertical air flow separation

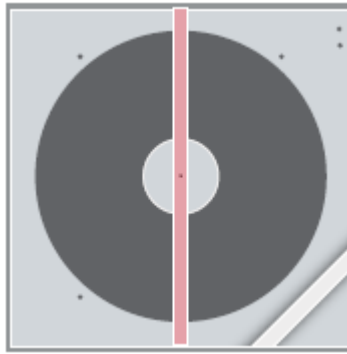

Fig. 18: Vertical air flow separation

Possible positioning of the cleaning rail with vertical air flow separation

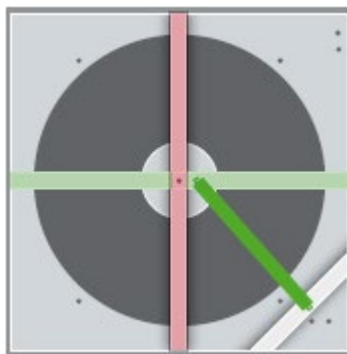

Fig. 19: Possible positioning of the cleaning rail

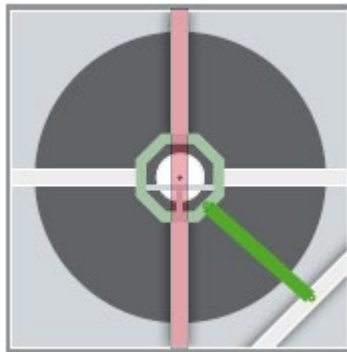



Fig. 20: Possible positioning of the cleaning rail

-  Unavailable area for attaching the cleaning rail
-  Available area for attaching the cleaning rail

Install cleaning rail

Personell qualification:

- Service technician

Personal protective equipment:

- Protective clothing
- Safety shoes
- Protective gloves

Pre-condition:

- The entire system is switched off and secured against being switched on again ↪ *Operating manual for the building control system.*
- The position of the cleaning rail was determined depending on the air flow separation.

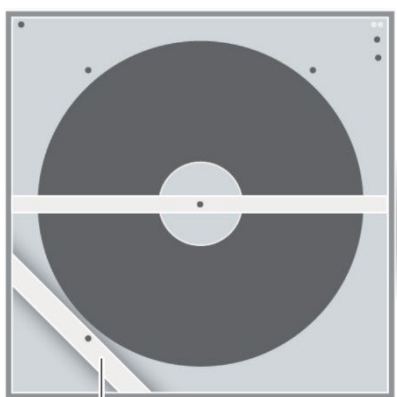
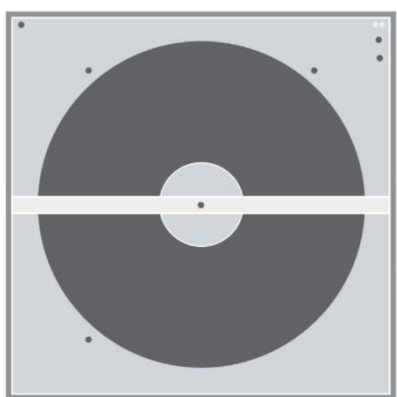

1

Fig. 21: Crossbeam



The cleaning rail must be installed on the exhaust air side of the rotary heat exchanger. If the rotor cleaning device is retrofitted and the rotary heat exchanger does not have a crossbeam (Fig. 21/1) for mounting the cleaning rail, the crossbeam (Fig. 21/1) must be retrofitted.

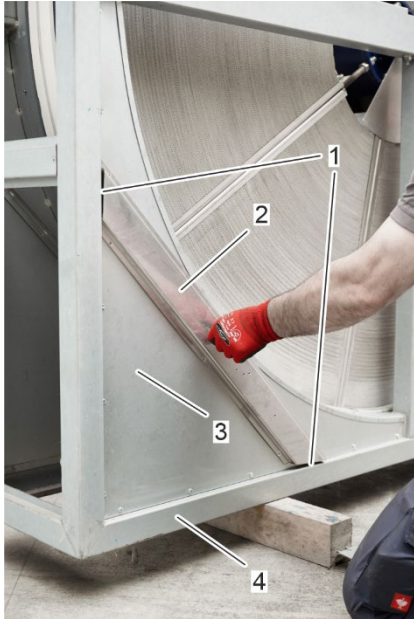

Fig. 22: Crossbeam alignment

1. Align the crossbeam (Fig. 22/2) on the housing of the rotary heat exchanger (Fig. 22/3) so that the mitres of the crossbeam (Fig. 22/1) are parallel to the housing frame (Fig. 22/4).



Fig. 23: Bolt crossbeam

2. Screw the crossbeam (Fig. 23/2) to the housing of the rotary heat exchanger (Fig. 23/3) using self-tapping screws (Fig. 23/1). Use all six drill holes (Fig. 24/1).

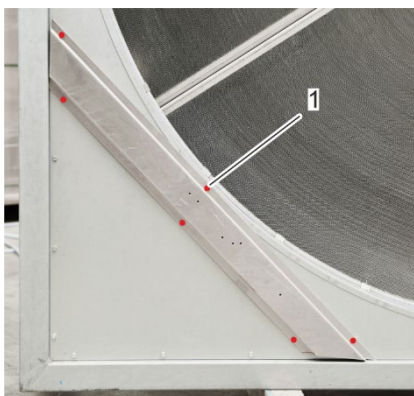

Fig. 24: Crossbeam drill holes

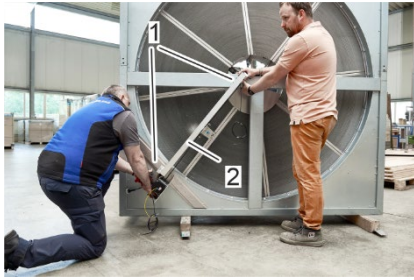

Fig. 25: Place the cleaning rail on the rotor frame

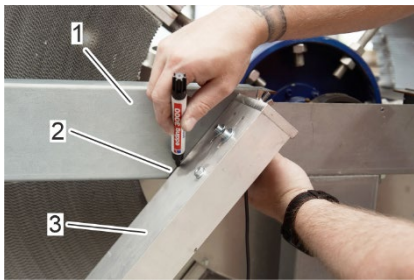

Fig. 26: Mark the position of the cleaning rail

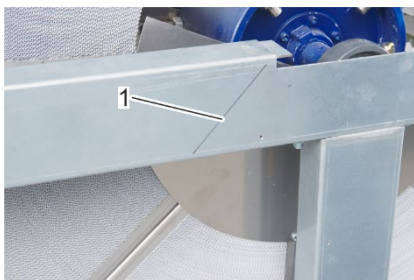

Fig. 27: Position of the cleaning rail

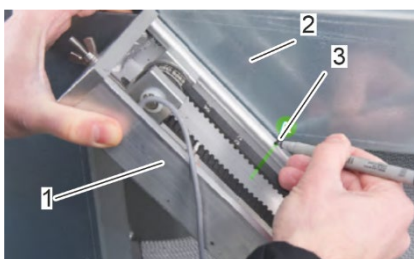

Fig. 28: Intersection of horizontal beam and cleaning rail

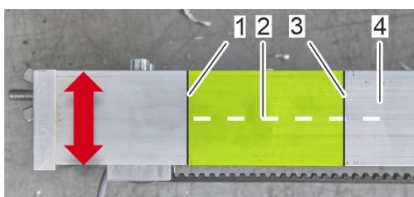

Fig. 29: Marking on backside of the cleaning rail

3. Hold the cleaning rail (Fig. 25/2) with two persons on the frame (Fig. 25/1) of the rotary heat exchanger. The end of the cleaning rail on the engine side must be at the outer end of the rotary heat exchanger. Make sure that the cleaning carriage can run over the entire rotor area.

4. Mark the position (Fig. 26/2) of the cleaning rail (Fig. 26/3) on the horizontal beam (Fig. 26/1) of the rotary heat exchanger frame with a clearly visible and waterproof pen if the airflow is separated vertically. In the case of horizontal airflow separation, the position of the cleaning rail must be marked on the vertical beam.



The marking (Fig. 27/1) makes it easier to position the cleaning rail during assembly.

5. Mark the intersection (Fig. 28/3) between the cleaning rail (Fig. 28/1) and the horizontal beam (Fig. 28/2) of the rotary heat exchanger frame with a line on the cleaning rail (Fig. 28/1).

6. Transfer the marking from step 3 (Fig. 29/3) to the back side of the cleaning rail (Fig. 29/4) that is in contact with the horizontal beam of the housing.



Available range for fixing hole

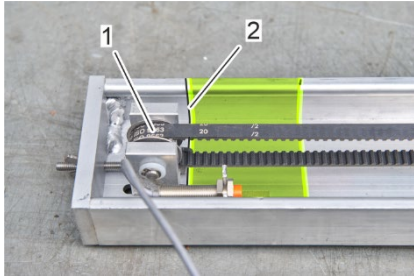

Fig. 30: Position of the deflection roller

7. Transfer the position (Fig. 30/2) of the deflection roller (Fig. 30/1) to the back side of the cleaning rail (Fig. 29/1) that is in contact with the horizontal beam of the housing.

8. Mark a drilling point on the central axis (Fig. 29/2) of the cleaning rail within the marked area.

9.



NOTICE!

Risk of damage to the toothed belt, the proximity sensor or the deflection roller.

Carefully drill a hole at the marked point using a 5 mm or 6 mm drill bit.



Fig. 31: Fasten the cleaning rail

10. Hold the cleaning rail (Fig. 31/1) at the mark determined in step 2 and fasten it to the horizontal beam (Fig. 31/2) of the rotary heat exchanger housing with a self-tapping screw (Fig. 31/3).



To attach the cleaning rail to the horizontal beam, it may be necessary to move the deflection roller to allow more space for screwing the cleaning rail to the horizontal beam. To align the deflection roller for optimum mountability, follow steps 11 to 17. Otherwise, continue the installation with step 18.



Fig. 32: Screws of the deflector roll

11. Loosen the screws of the deflector roll (Fig. 32/1).



Fig. 33: Loosen the wing nut

12. Loosen the wing nut (Fig. 33/1) by turning it counterclockwise to relieve the toothed belt (Fig. 33/2) tension.

13. Move the deflection roller until there is sufficient space for screwing the cleaning rail to the horizontal beam.

14. Fasten the cleaning rail to the horizontal beam as described in step 10.



Fig. 34: Align the motor-side end of the cleaning rail

15. Move the deflection roller back to its original position.
16. Tighten the wing nut (Fig. 33/1) to tension the toothed belt (Fig. 33/2) until both belt strands are parallel to each other.
17. Tighten both screws (Fig. 32/1) of the deflection roller.
18. Position the motor-side end of the cleaning rail (Fig. 34/1) on the crossbeam (Fig. 34/2) so that the cleaning carriage can cover the entire rotor.

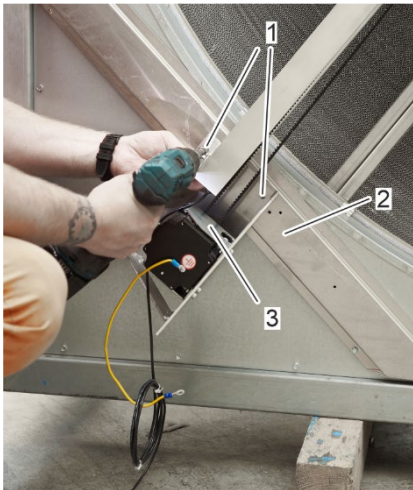

Fig. 35: Fasten the motor-side end of the cleaning rail to the crossbeam

19. Fasten the motor-side end of the cleaning rail (Fig. 35/3) to the cross beam (Fig. 35/2) with self-tapping screws (Fig. 35/1).
 - ⇒ The cleaning rail is mounted and adjusted on the rotor housing.

Set the travel path of the cleaning carriage



Fig. 36: Cleaning carriage top position

1. Move the cleaning carriage (Fig. 36/1) to the very top position by hand. Avoid contact of the cleaning carriage (Fig. 36/1) with the horizontal beam (Fig. 36/2) of the rotor frame.

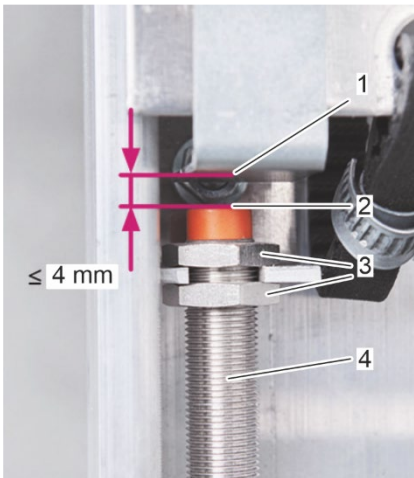

Fig. 37: Maximum switching distance

2. Ensure that the maximum switching distance of 4 mm between the proximity sensor (Fig. 37/2) and the cleaning carriage (Fig. 37/1) is maintained. Otherwise adjust the distance between the proximity sensor (Fig. 37/2) and the cleaning carriage (Fig. 37/1) using the thread (Fig. 37/4) and the nuts (Fig. 37/3) on the proximity sensor.



Fig. 38: Cleaning carriage bottom position

3. Move the cleaning carriage (Fig. 38/1) to the very bottom position at the rotor circumference by hand. Avoid contact of the cleaning carriage (Fig. 38/1) with the cross beam (Fig. 38/2) of the rotor frame.

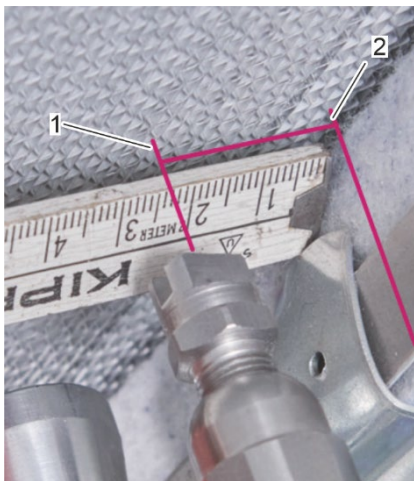

Fig. 39: Set distance between water nozzle and rotor circumference

4. Set the distance between the centre point of the high-pressure water nozzle (Fig. 39/1) and the rotor circumference (Fig. 39/2) to 2.5 cm by moving the cleaning carriage by hand using a folding ruler (optional).

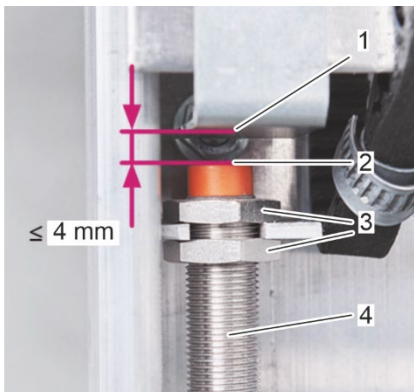

Fig. 40: Maximum switching distance

5. Ensure that the maximum switching distance of 4 mm between the proximity sensor (Fig. 40/2) and the cleaning carriage (Fig. 40/1) is maintained. Otherwise adjust the distance between the proximity sensor (Fig. 40/2) and the cleaning carriage (Fig. 40/1) using the thread (Fig. 40/4) and the nuts (Fig. 40/3) on the proximity sensor.

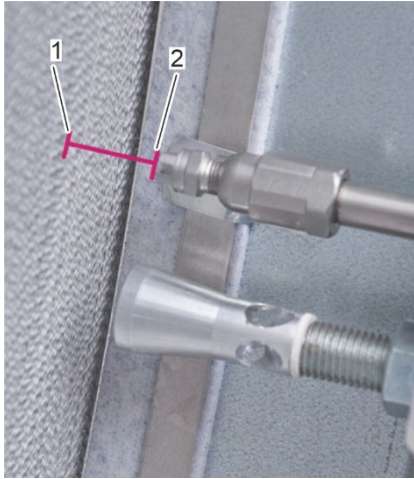

Fig. 41: Distance between water nozzle and rotor surface

6. Measure the distance between the high-pressure water nozzle (Fig. 41/2) and the rotor surface (Fig. 41/1).



Fig. 42: Adjust the distance of the water nozzle to the rotor surface

7. If the distance is less or more than 2.5 cm, loosen the setscrew (Fig. 42/2) and adjust the high pressure water nozzle (Fig. 42/1) moving it away from or onto the rotor surface (Fig. 42/3) to a distance of 2.5 cm to the rotor surface (Fig. 42/3) and tighten the setscrew (Fig. 42/2).

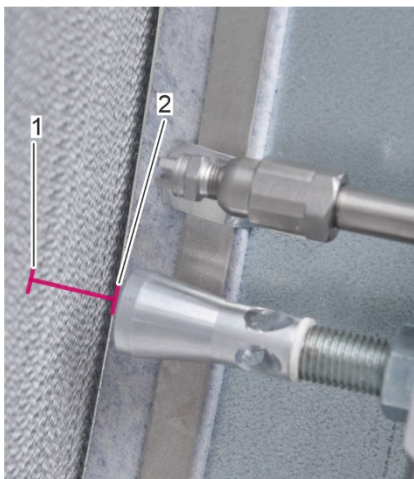

Fig. 43: Distance between compressed air nozzle and rotor surface

8. Measure the distance between the compressed air nozzle (Fig. 43/2) and the rotor surface (Fig. 43/1).

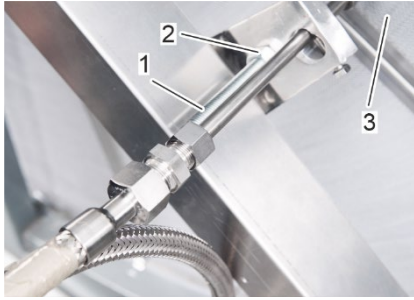

Fig. 44: Adjust the distance of the compressed air nozzle to the rotor surface

9. If the distance is less or more than 2.5 cm, loosen the supply-side locknuts (Fig. 44/2) and the rotor-side locknut (Fig. 45/1) and adjust the compressed air nozzle (Fig. 44/1) by moving it away or onto the rotor surface (Fig. 44/3) to a distance of 2.5 cm from the rotor surface (Fig. 44/3). Tighten the supply-side locknuts (Fig. 44/2) and the rotor-side locknut (Fig. 45/1).

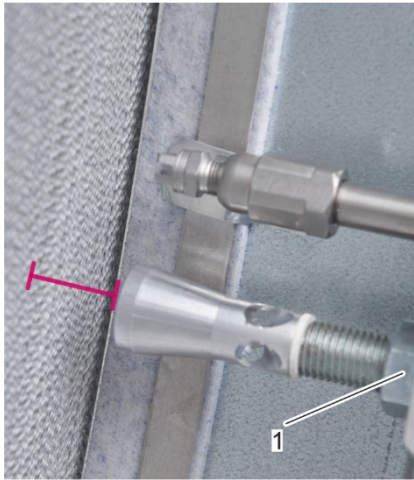

Fig. 45: Rotor-side locknut on the compressed air nozzle

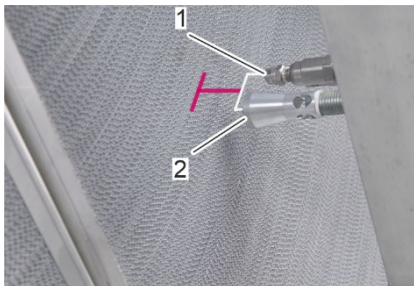

Fig. 46: Same nozzle distance to the rotor surface

10. Make sure, that the high-pressure water nozzle (Fig. 46/1) and the compressed air nozzle (Fig. 46/2) have the same distance to the rotor surface.
11. Recheck all required distances to avoid irreparable damage during operation.



Fig. 47: Cleaning carriage middle position

12. Manually move the cleaning carriage to the centre of the cleaning rail (Fig. 47).



In the event of an error reset, this ensures a response time for reaching an emergency stop switch before the cleaning carriage collides with the rotor housing.

6.2.2. Drip pan

Install drip pan

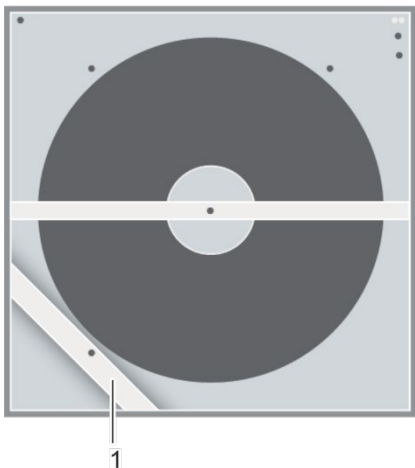

Fig. 48: Crossbeam on extract air side



The drip pan must be installed on the extract air side of the rotary heat exchanger. If the rotor cleaning device is retrofitted and the rotary heat exchanger does not have a crossbeam (Fig. 48/1) for mounting the drip pan on the extract air side, the crossbeam (Fig. 48/1) must be retrofitted analogous to chapter 6.2.1 Cleaning rail on page 39.

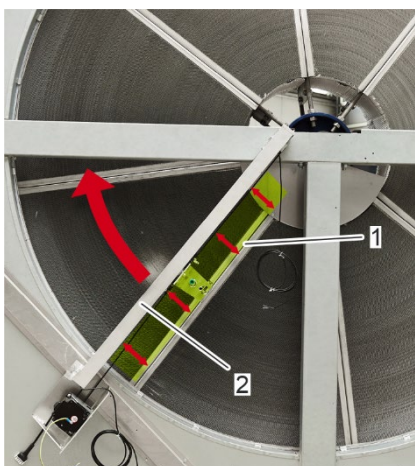

Fig. 49: Align rotor

1. Turn the rotor by hand and align the inside of two adjacent rotor segments (Fig. 49/1) parallel to the cleaning rail (Fig. 49/2).



Do not rotate the rotor after parallel alignment!

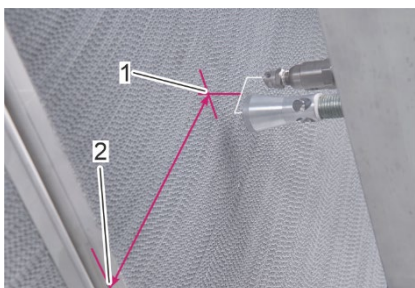

Fig. 50: Distance between the centre of the nozzle pair and the rotor segment

2. Measure the distance between the centre of the nozzle pair (Fig. 50/1) and the edge of the rotor segment (Fig. 50/2).

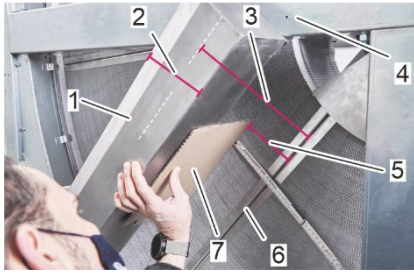

Fig. 51: Align drip pan

3. Hold the drip pan (Fig. 51/1) on the rotor frame (Fig. 51/4) on the exhaust air side.
4. Align the drip pan (Fig. 51/1) parallel to the rotor segment (Fig. 51/6). The distance to be set (Fig. 51/5) results from the distance measured in step 2 (Fig. 51/3) minus half the width (Fig. 51/2) of the drip pan (Fig. 51/1).



Use a suitable measuring stop (Fig. 51/7) (e.g. a piece of cardboard) to measure the distance between the drip pan and the rotor segment.

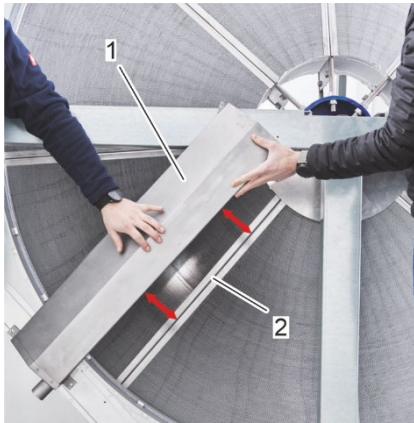

Fig. 52: Check parallelism of the drip pan

5. Before attaching the drip pan (Fig. 52/1), check the parallelism between the drip pan (Fig. 52/1) and the rotor segment (Fig. 52/2) and align if necessary.



It is helpful to fix the drip pan (Fig. 52/1) to the horizontal beam (Fig. 54/3) and to the crossbeam (Fig. 53/1) of the rotor frame with suitable clamps before fastening it so that it does not slip during the screwing process



Fig. 53: Fasten the drip pan

6. Use self-tapping screws (Fig. 53/2) to fasten the drip pan (Fig. 53/3) to the crossbeam (Fig. 53/1) and to the horizontal beam (Fig. 54/3) of the rotor frame using the existing drill holes (Fig. 54/1,2,4).

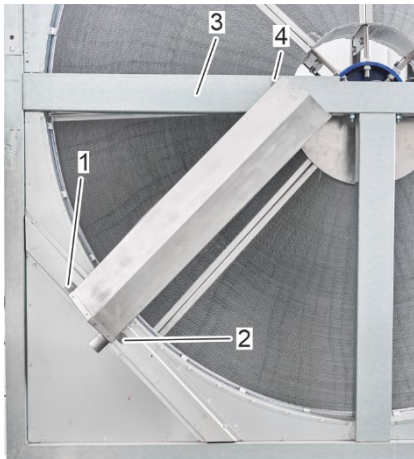

Fig. 54: Drip pan drill holes

6.2.3. Cleaning rail cover

Install cleaning rail cover



Fig. 55: Cleaning rail cover drill holes

1. Place the cleaning rail cover (Fig. 56/1) on the cleaning rail so that the drill holes in the cover (Fig. 55/1) line up with the holes in the cleaning rail.



Fig. 56: Fasten the cleaning rail cover

2. Screw the cleaning rail cover (Fig. 56/1) to the cleaning rail.
 - ⇒ The cleaning rail cover is mounted on the cleaning rail.

6.2.4. High-pressure water supply

Connect high-pressure hot water supply

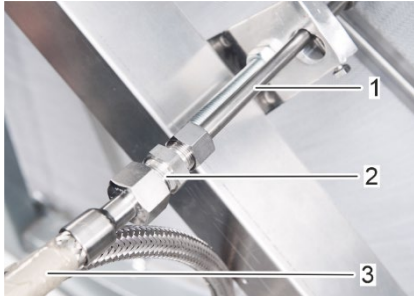

Fig. 57: Connect the water supply

1. Connect the high-pressure water nozzle (Fig. 57/1) using a suitable connection technique with an electromagnetic hydraulic valve and with the on-site high-pressure water supply (Fig. 57/3).



Klingenburg recommends using a Parker Ermeto hydraulic screw connection (Fig. 57/2). The electromagnetic hydraulic valve is not included in the scope of delivery.

6.2.5. Compressed air supply

Connect compressed air supply



Fig. 58: 3/2-way solenoid valve

1. Mount the 3/2-way solenoid valve (Fig. 58) in a suitable place on the rotor frame.



To avoid unnecessarily long power cables and compressed air hoses, mount the solenoid valve as closely as possible to the rotor cleaner control and the cleaning rail.

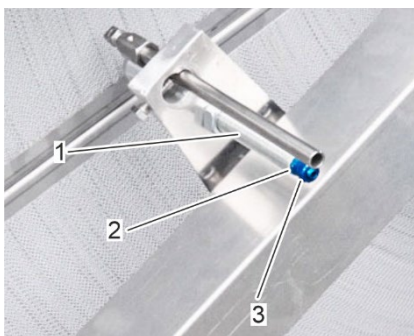

Fig. 59: Compressed air nozzle union nut

2. Loosen the union nut (Fig. 59/3) from the screw-in stud (Fig. 59/2) on the compressed air nozzle (Fig. 59/1).

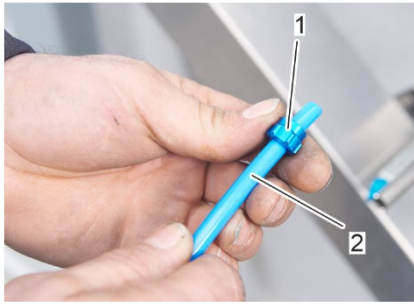

Fig. 60: Slide union nut on compressed air hose

3. Slide the union nut (Fig. 60/1) onto one end of the compressed air hose (Fig. 60/2).



Fig. 61: push compressed air hose in compressed air nozzle

4. Push the compressed air hose (Fig. 61/3) onto the screw-in stud (Fig. 61/2) on the compressed air nozzle (Fig. 61/1).

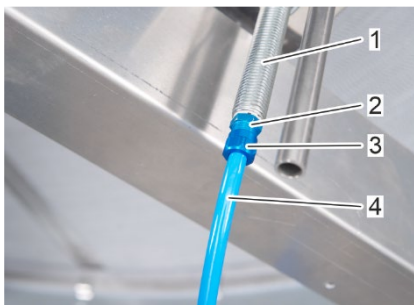

Fig. 62: Secure the compressed air hose

5. Secure the compressed air hose (Fig. 62/4) on the compressed air nozzle (Fig. 62/1) by screwing the union nut (Fig. 62/3) onto the screw-in stud (Fig. 62/2).

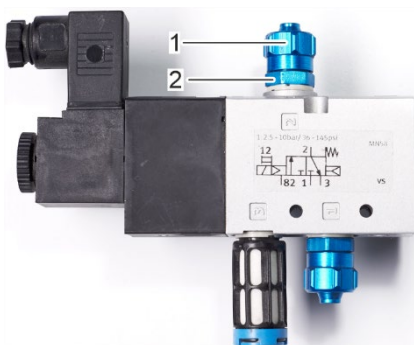

Fig. 63: Loosen union nut on connection 2

6. Loosen the union nut (Fig. 63/1) from the screw-in stud (Fig. 63/2) on connection 2 of the 3/2-way solenoid valve.

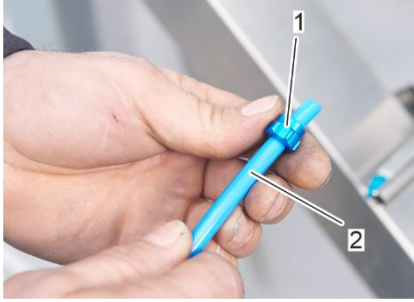

Fig. 64: Slide the union nut on the other end of the compressed air hose

7. Slide the union nut (Fig. 64/1) onto the other end of the compressed air hose (Fig. 64/2).



Fig. 65: Secure the compressed air hose on connection 2

8. Push the valve-side end of the compressed air hose (Fig. 65/1) onto the screw-in stud on connection 2 (Fig. 65/3) of the 3/2-way solenoid valve (Fig. 65/4).
9. Secure the compressed air hose (Fig. 65/1) on connection 2 of the 3/2-way solenoid valve by screwing the union nut (Fig. 65/2) onto the screw-in stud (Fig. 65/3).

10.



NOTICE!

Risk of property damage due to improper routing of the compressed air hose.

Lay and fasten the compressed air hose in such a way that it cannot be pinched between the rotor and the frame of the rotor or in the cleaning carriage and is not subject to tensile stress when the cleaning carriage is moved.

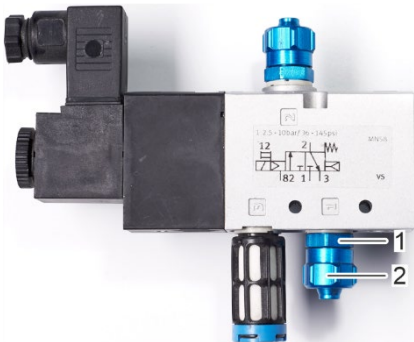

Fig. 66: Loosen union nut on connection 1

11. Loosen the union nut (Fig. 66/2) from the screw-in stud (Fig. 66/1) on connection 1 of the 3/2-way solenoid valve.

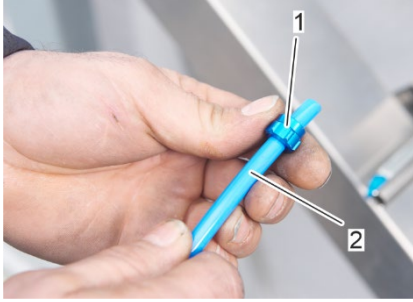

Fig. 67: Slide union nut on supply hose

12. Slide the union nut (Fig. 67/1) onto the compressed air supply hose (Fig. 67/2).
13. Push the compressed air supply hose onto the screw-in stud on connection 1 of the 3/2-way solenoid valve similar to the connection of connection 2 in step 8.
14. Secure the compressed air supply hose on connection 1 of the 3/2-way solenoid valve by screwing the union nut onto the screw-in stud similar to step 9.
15. Connect the compressed air supply hose to the on-site compressed air source.

⇒ The compressed air supply is connected.

6.2.6. Clock sensor

Installing the clock sensor

Personnel qualification:

- Service technician

Personal protective equipment:

- Protective clothing
- Safety shoes



Fig. 68: Sensor holders



If the rotor of the rotary heat exchanger is controlled with an OJ Electronics controller, an inductive rotor guard with associated sensor holder (Fig. 68/2) is already mounted in the rotor housing. The clock sensor must not be inserted into the existing sensor holder (Fig. 68/2), otherwise the two inductive sensors will interfere with each other. The supplied holder for the clock sensor (Fig. 68/1) must be mounted in the rotor housing and the cycle sensor inserted in such a way that a minimum distance of 2.5 cm is maintained between the rotor guard of the OJ rotor controller and the clock sensor of the rotor cleaning device.

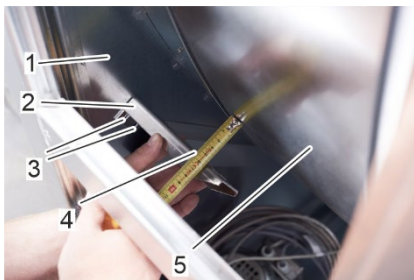

Fig. 69: Align clock sensor to the rotor

1. Align the clock sensor holder (Fig. 69/2) inside the rotor housing (Fig. 69/1) in a distance of 55 mm (Fig. 69/4) parallel to the rotor (Fig. 69/5).



To avoid unnecessarily long power cables, mount the align the clock sensor holder as closely as possible to the rotor cleaner control.

2. Mark the position of the long holes (Fig. 69/3) on the rotor housing with a clearly visible waterproof pen.
3. Drill two holes (Fig. 71/1) in the centre of the marked long holes (Fig. 70/1) using a 8 mm drill bit.



Fig. 70: Long hole marks



Fig. 71: Drill holes

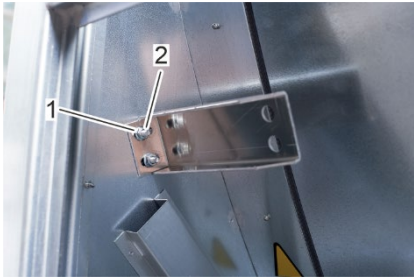

Fig. 72: Fasten clock sensor holder

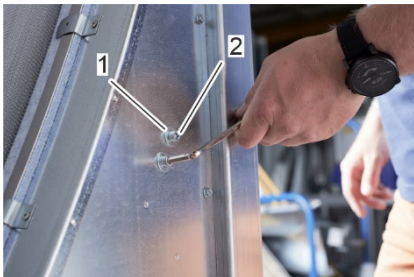

Fig. 73: Fasten clock sensor holder

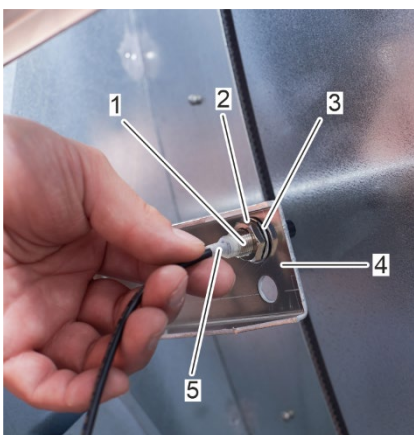

Fig. 74: Insert clock sensor in the holder

4. Fasten the clock sensor holder to the rotor housing with the screws (Fig. 73/2) and the associated nuts (Fig. 72/2). Use washers under the screw heads (Fig. 73/1) and washers under the nuts (Fig. 72/1).

5. Screw the nut (Fig. 74/2) onto the thread (Fig. 74/1) of the clock sensor (Fig. 74/5) and slide on a washer (Fig. 74/3).

6. Insert the clock sensor (Fig. 74/5) into the clock sensor holder (Fig. 74/4).

7. Screw the locknut (Fig. 75/2) on the thread of the clock sensor (Fig. 75/1).

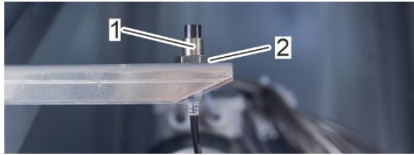

Fig. 75: Lock nut

8. Screw a screw (Fig. 76/1) with washers (Fig. 76/2) into the rotor (Fig. 76/4) in line with the clock sensor (Fig. 76/3). The washers act as contactor (Fig. 77/2) for the clock sensor.

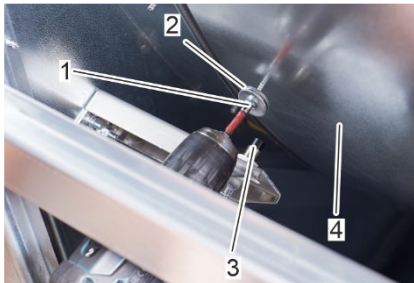

Fig. 76: Fasten clock sensor contactor

9. Adjust the clock sensor (Fig. 77/2) via the nuts (Fig. 77/3 and Fig. 75/2) to maintain the required switching distance of 10 – 20 mm between the clock sensor (Fig. 77/2) and the contactor (Fig. 77/1).



Fig. 77: Adjust clock sensor

6.2.7. Rotor cleaner control

Installing the rotor cleaner control



NOTICE!

Incorrect mechanical installation can cause damage to the rotor cleaner drive!

- Only have the rotor cleaner control installed by qualified electricians.
- Only mount the rotor cleaner control in such a way that the connection sockets do not point upwards.
- When connecting the rotor cleaner control, make sure that no water can collect around cables in bushings.
- Only mount the rotor cleaner drive on a flat, firm surface.
- Mount the rotor cleaner drive with four screws using the existing mounting holes.
- Do not expose the rotor cleaner drive to direct sunlight.

Install rotor cleaner control

Personell qualification:

- Electrician

Personal protective equipment:

- Protective clothing
- Safety shoes



Fig. 78: Housing screws



Fig. 79: Drill holes for mounting screws



Fig. 80: Housing screws

1. Loosen all 6 housing screws (Fig. 78/1) by a quarter turn to the left and remove the front cover.

2. Fasten the rotor cleaner control to the rotor housing using the 4 existing drill holes (Fig. 79/1) with self-tapping screws.

3. Place the front cover on the rotor cleaner control and tighten all 6 housing screws (Fig. 80/1) by a quarter turn to the right.

6.2.8. Rotor cleaner drive

Incorrect mechanical installation



NOTICE!

Incorrect mechanical installation can cause damage to the rotor cleaner drive!

- Only have the rotor cleaner drive installed by qualified electricians.
- Only mount the rotor cleaner drive in such a way that a free flow of air over the cooling fins of the rotor cleaner drive is guaranteed.
- Only mount the rotor cleaner drive in such a way that the connection sockets do not point upwards.
- When connecting the rotor cleaner drive, make sure that no water can collect around cables in bushings.
- Install the rotor cleaner drive with a maximum vertical tilt of 45° or less to ensure optimal cooling. The cooling fins on the back of the housing must always be cooled by natural thermal updrafts behind the cooling fins.
- Only mount the rotor cleaner drive on a flat, firm surface
- Mount the rotor cleaner drive with at least 3 screws using the existing mounting holes.
- Do not expose the rotor cleaner drive to direct sunlight.



In order to avoid unnecessarily long power cables, position the rotor cleaner drive on the rotor housing as close as possible to the rotor cleaner control and the cleaning rail.

Installing the rotor cleaner drive

Personell qualification:

- Electrician

Personal protective equipment:

- Protective clothing
- Safety shoes

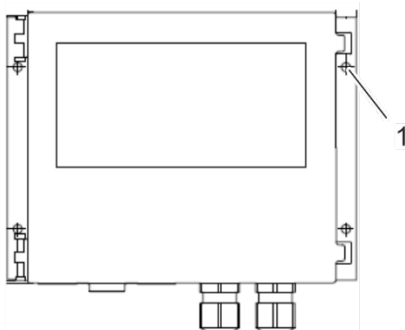

Fig. 81: Rotor cleaner drive drill holes

1. Position the cleaner drive in a suitable position on the rotor housing.
2. Fasten the cleaner drive to the rotor housing using at least 3 drill holes (Fig. 81/1) with self-tapping screws.

6.3. Electrical installation

6.3.1. Rotor cleaner control

Connect rotor cleaner control

Personnel qualification:

- Electrician

Personal protective equipment:

- Protective clothing
- Safety shoes

Requirements:

- The entire system is switched off and secured against being switched on again ↪ *Operating manual for the building control system.*
- The cleaning rail is installed and adjusted.
- The rotor cleaner drive is installed mechanically.
- The cleaner control is installed mechanically.
- The clock sensor is installed mechanically.

Removing the front cover



Fig. 82: Housing screws

1. Loosen all 6 housing screws (Fig. 82/1) by a quarter turn to the left and remove the front cover.

Internal modbus

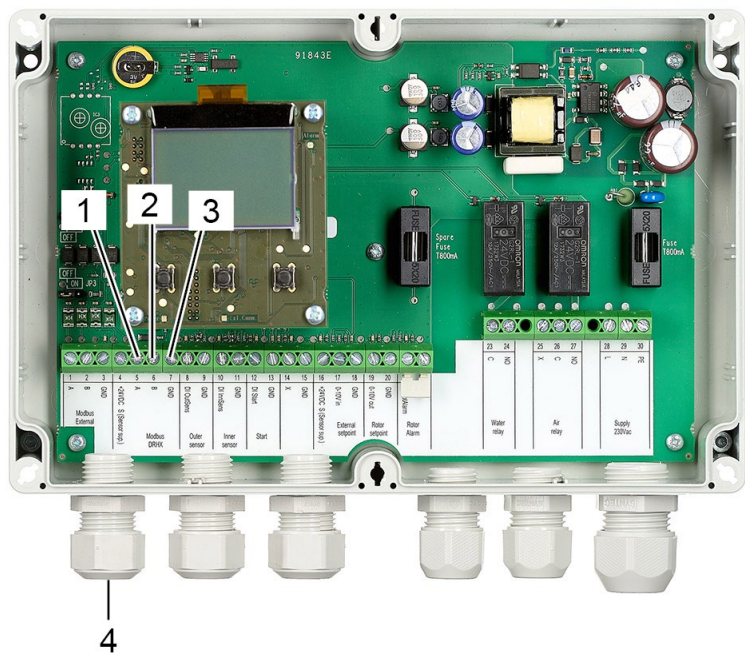

Fig. 83: Terminals internal modbus



Fig. 84: Modbus cable

2. Insert the modbus wires (Fig. 84/1-3) through the cable socket (Fig. 83/4)
3. Connect the brown-white wire (Fig. 84/1) to terminal 5 (Fig. 83/1, A).
4. Connect the brown wire (Fig. 84/2) to terminal 6 (Fig. 83/2, B).
5. Connect the red-white wire (Fig. 84/3) to terminal 7 (Fig. 83/3, GND).

Rotor circumference proximity sensor

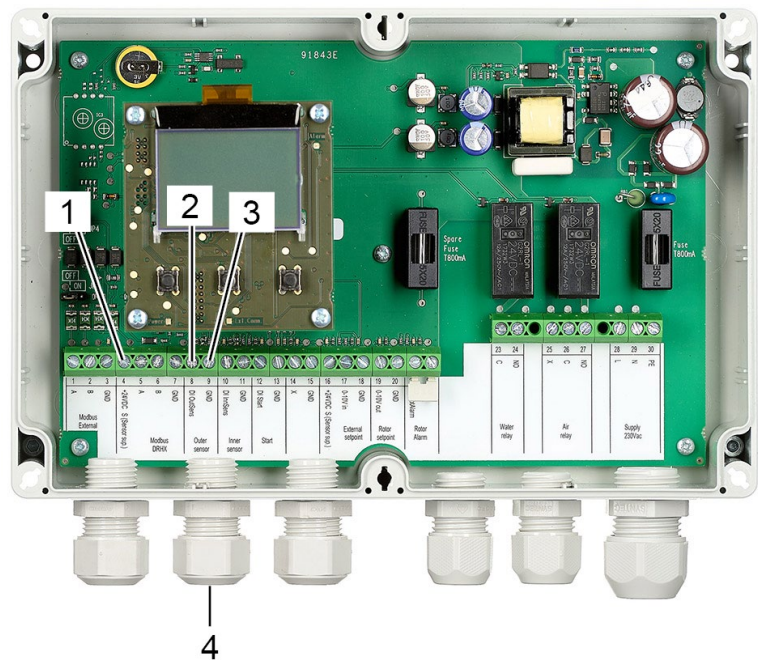

Fig. 85: Cable socket and terminals rotor circumference proximity sensor

6. Insert the wires of the rotor circumference proximity sensor connection cable through the cable socket (Fig. 85/4).
7. Connect the brown power supply wire to terminal 4 (Fig. 85/1, +24 VDC S (Sensor sup.)) of the rotor cleaner control.
8. Connect the black signal wire to terminal 8 (Fig. 85/2, DI OutSens) of the rotor cleaner control.
9. Connect the blue ground connection wire to terminal 9 (Fig. 85/3, GND) of the rotor cleaner control.

Rotor centre proximity sensor

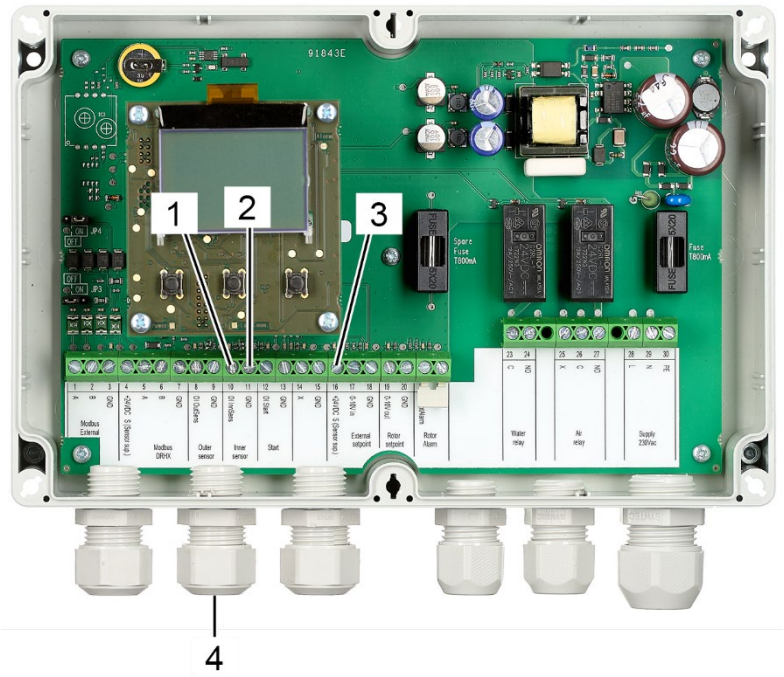

Fig. 86: Cable socket and terminals rotor centre proximity sensor

10. Insert the wires of the rotor centre proximity sensor connection cable through the cable socket (Fig. 86/4).
11. Connect the black signal wire to terminal 10 (Fig. 86/1, DI InnSens) of the rotor cleaner control.
12. Connect the blue ground wire to terminal 11 (Fig. 86/2, GND) of the rotor cleaner control.
13. Connect the brown power supply wire to terminal 16 (Fig. 86/3, +24 VDC S (Sensor sup.)) of the rotor cleaner control.

External rotor speed control signal for normal operation

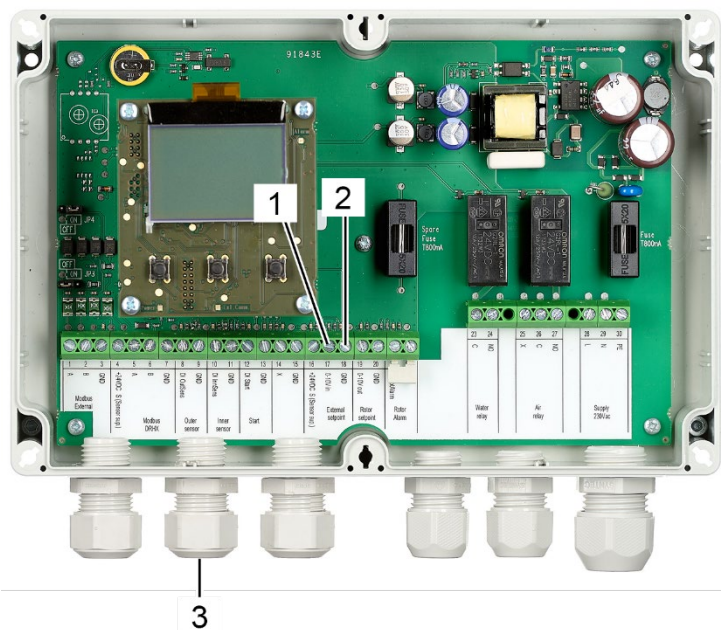

Fig. 87: Terminals external rotor speed control signal from the higher-level control

14. Insert the wires of the external 0-10 V signal cable through the cable socket (Fig. 87/3)
15. Connect external 0-10 V input signal wire to terminal 17 (Fig. 87/1, 0-10V in).
16. Connect the ground wire of the external 0-10 V input signal to terminal 18 (Fig. 87/2, GND).

Rotor speed control signal for cleaning operation

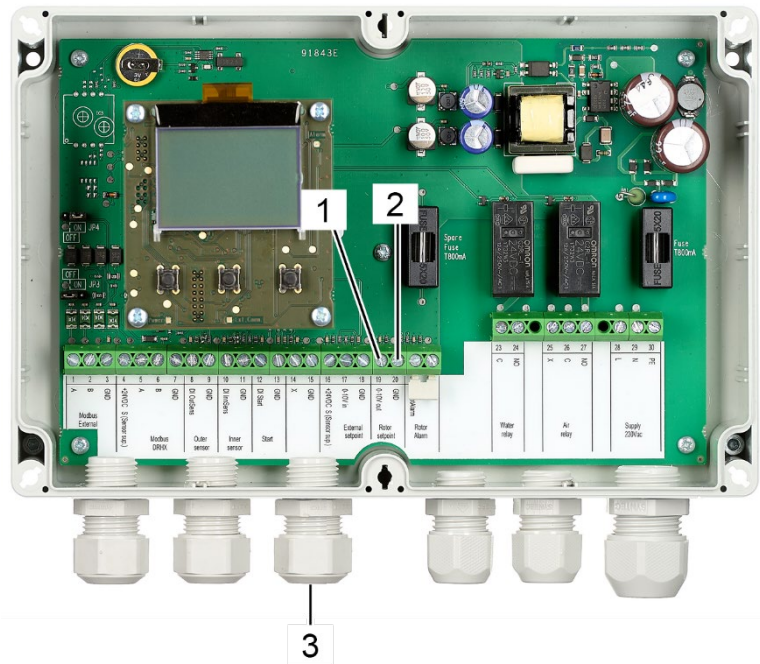

Fig. 88: Terminals internal rotor speed control signal to the rotor control of the rotary heat exchanger

17. Insert the wires of the internal rotor speed control signal through the cable socket (Fig. 88/3).
18. Connect the 0-10 V output signal wire to terminal 19 (Fig. 88/1, 0-10V out).
19. Connect the ground wire of the 0-10V output signal to terminal 20 (Fig. 88/2, GND).
20. Connect the other end of the rotor speed control signal cable to the rotor control of the rotary heat exchanger.



Pay attention to correct polarity!

Power supply for the relays and valves

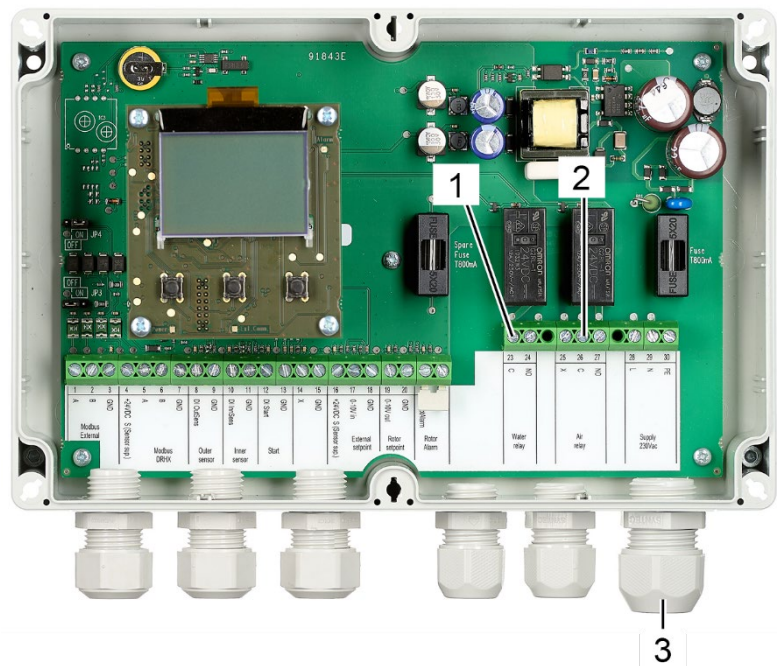

Fig. 89: Terminals for the relay and valve power supply

21. Insert a 230 V power supply cable through the cable socket (Fig. 89/3).



This cable is used to supply power to the water relay and the compressed air relay as well as the corresponding solenoid valves.

22. Connect each wire (L, N, PE) separately to a suitable cable terminal with at least three slots (e.g. plug-in terminals, screw terminals).
23. Connect the terminals 23 (Fig. 89/1) and 26 (Fig. 89/2) of the rotor cleaner control to the cable terminal to which the L wire of the 230 v power supply cable is connected.

Water relay

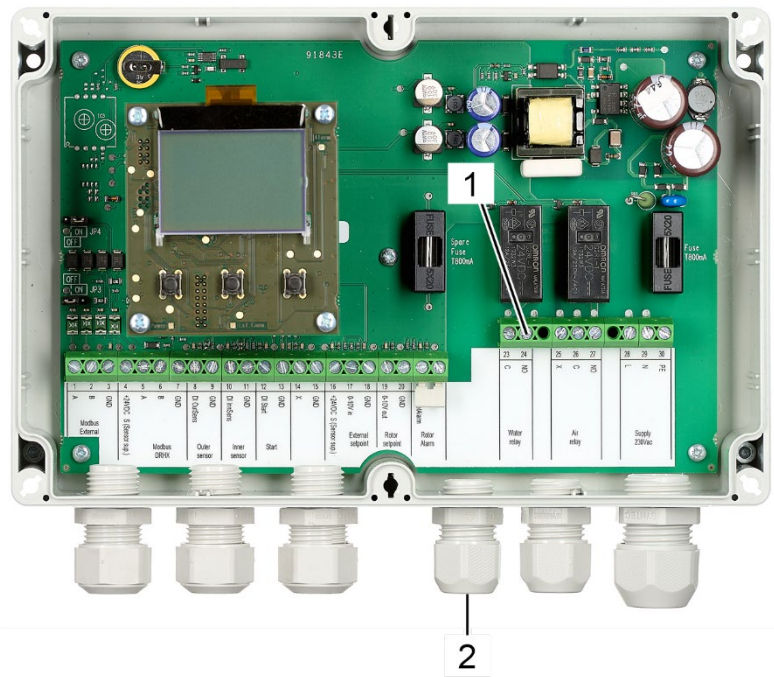

Fig. 90: Terminals water relay

24. Insert the wires of the water relay (power supply wire and neutral wire) through the cable socket (Fig. 90/2).
25. Connect the power supply wire of the water relay to terminal 24 (Fig. 90/1, NO).
26. Connect the neutral wire of the water relay to the cable terminal to which the N wire of the 230 V power supply cable is connected.

Compressed air relay

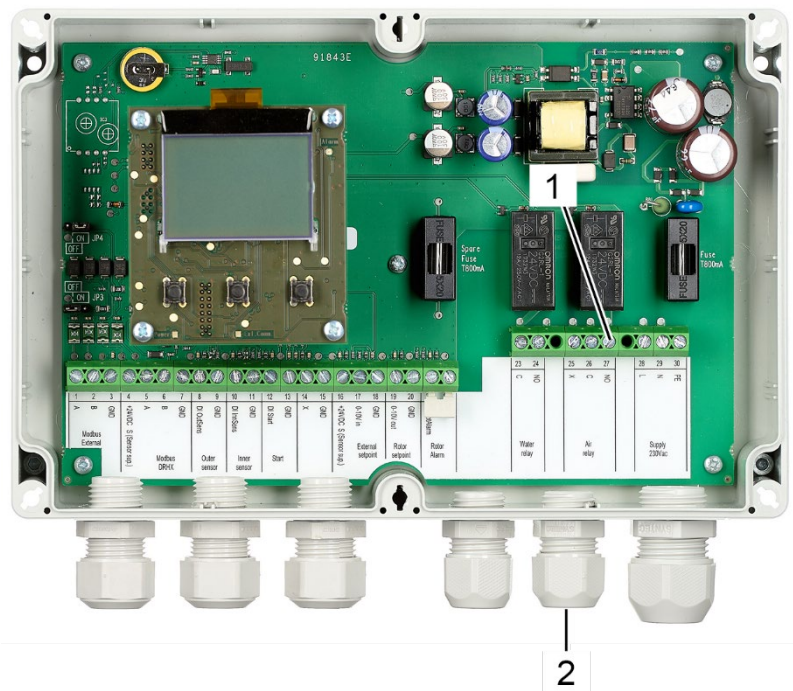

Fig. 91: Terminals compressed air relay

27. Insert the wires of the compressed air relay (power supply wire and neutral wire) through the cable socket (Fig. 91/2).
28. Connect the power supply wire of the compressed air relay to terminal 27 (Fig. 91/1, NO).
29. Connect the neutral wire of the compressed air relay to the cable terminal to which the N wire of the 230 V power supply cable is connected.

External start (optional)

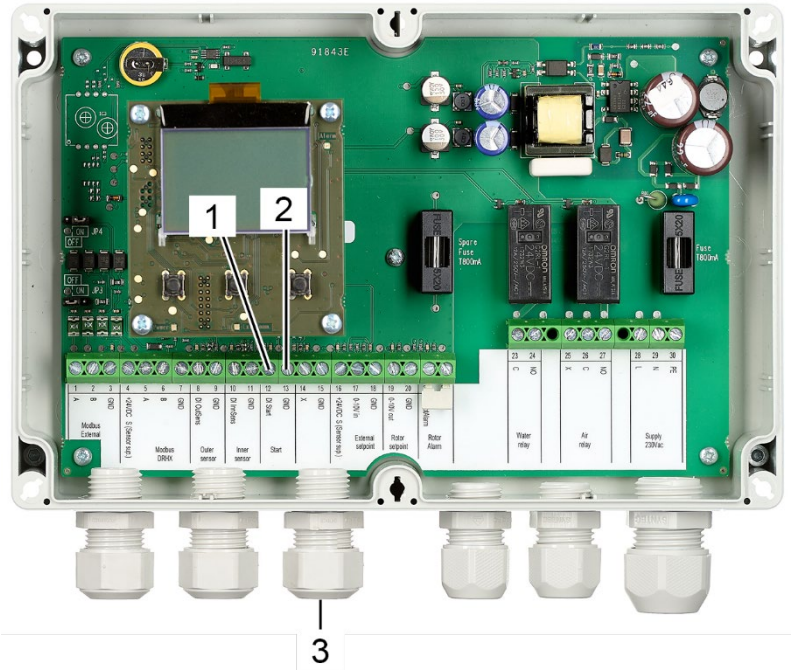

Fig. 92: Terminals external start signal

30. Insert the external start wires through the cable socket (Fig. 92/3).
31. Connect the external start input signal wire to terminal 12 (Fig. 92/1, DI Start).
32. Connect the external start ground wire to terminal 13 (Fig. 92/2, GND).

Rotor cleaner control power supply

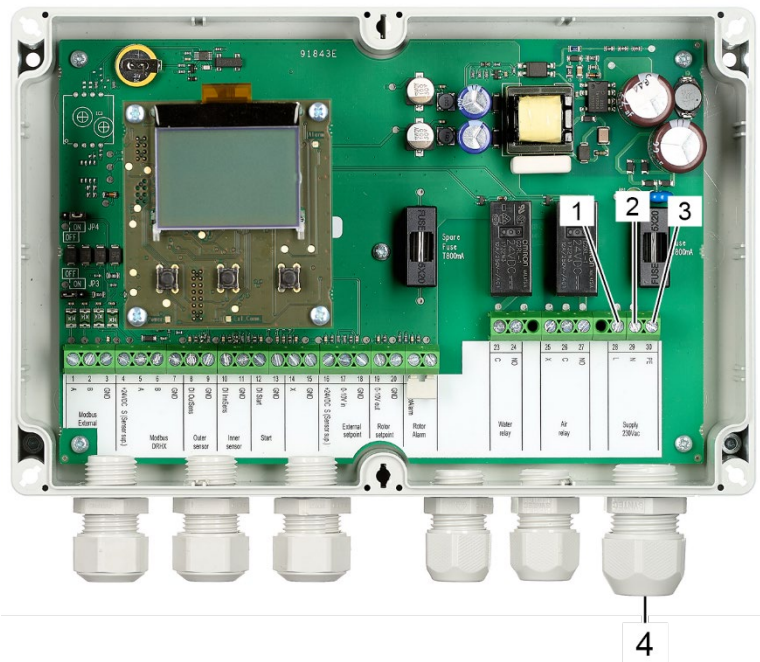

Fig. 93: Terminals power supply

33. Insert the power supply cable through the cable socket (Fig. 93/4).
34. Connect the phase wire to terminal 28 (Fig. 93/1, L).
35. Connect the neutral wire to terminal 29 (Fig. 93/2, N).
36. Connect the protective wire to terminal 30 (Fig. 93/3, PE).

Close front cover



Fig. 94: Housing screws

37. Place the front cover on the rotor cleaner control and tighten all 6 housing screws (Fig. 94/1) by a quarter turn to the right.

6.3.2. Rotor cleaner drive

Connect rotor cleaner drive

Personnel qualification:

- Electrician

Personal protective equipment:

- Protective clothing
- Safety shoes

Requirements:

- The entire system is switched off and secured against being switched on again *↪ Operating manual for the building control system.*
- The cleaning rail is installed and adjusted.
- The rotor cleaner drive is installed mechanically.
- The cleaner control is installed mechanically.
- The clock sensor is installed mechanically.

Open front cover

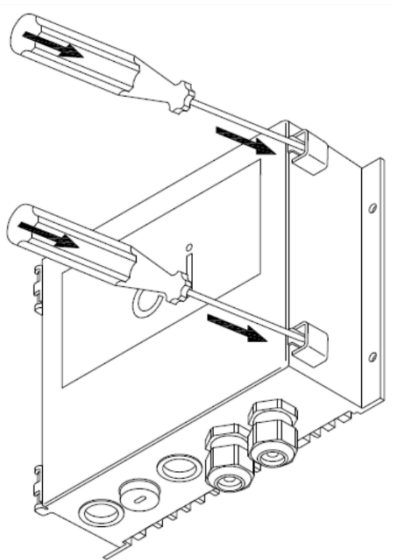

Fig. 95: Locking clips front cover

1. Open the front cover of the rotor cleaner drive by pressing in the locking clips with a suitable tool (e.g. slotted screwdriver).



To free up space for installation and service work, the cover can be removed completely from the rotor cleaner drive enclosure.

The specially designed hinged brackets allow the cover to be removed with a light pull.

Connect power supply

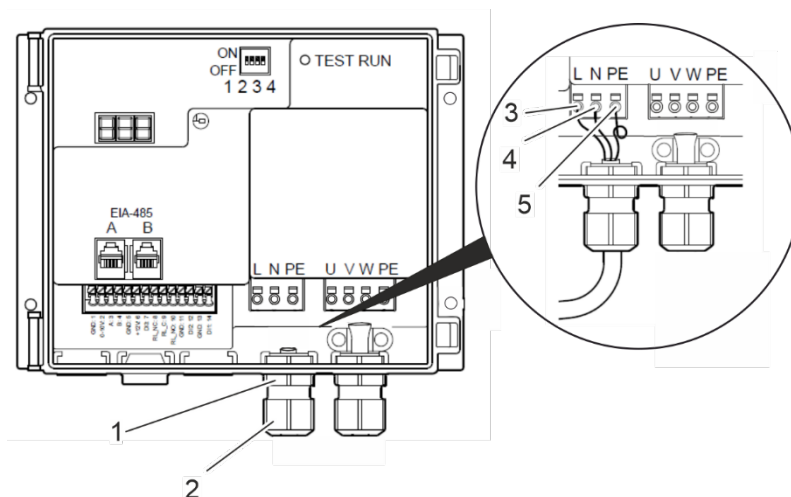

Fig. 96: Terminals Power supply

2. Loosen the nut (Fig. 96/2) of the cable entry (Fig. 96/1).
3. Slide the nut (Fig. 96/2) of the cable entry (Fig. 96/1) over the power cable.
4. Insert the power cable through the cable entry (Fig. 96/1) into the rotor cleaner drive.
5. Connect the phase wire to terminal L (Fig. 96/3).
6. Connect the neutral wire to terminal N (Fig. 96/4).
7. Connect the protective wire to terminal PE (Fig. 96/5).
8. Secure the power cable in the cable entry (Fig. 96/1) by tightening the nut (Fig. 96/2).



The cables must be secured against tension and torsion by the cable gland. Ensure that the cables are not already subjected to tension or torsion when tightening the nut.

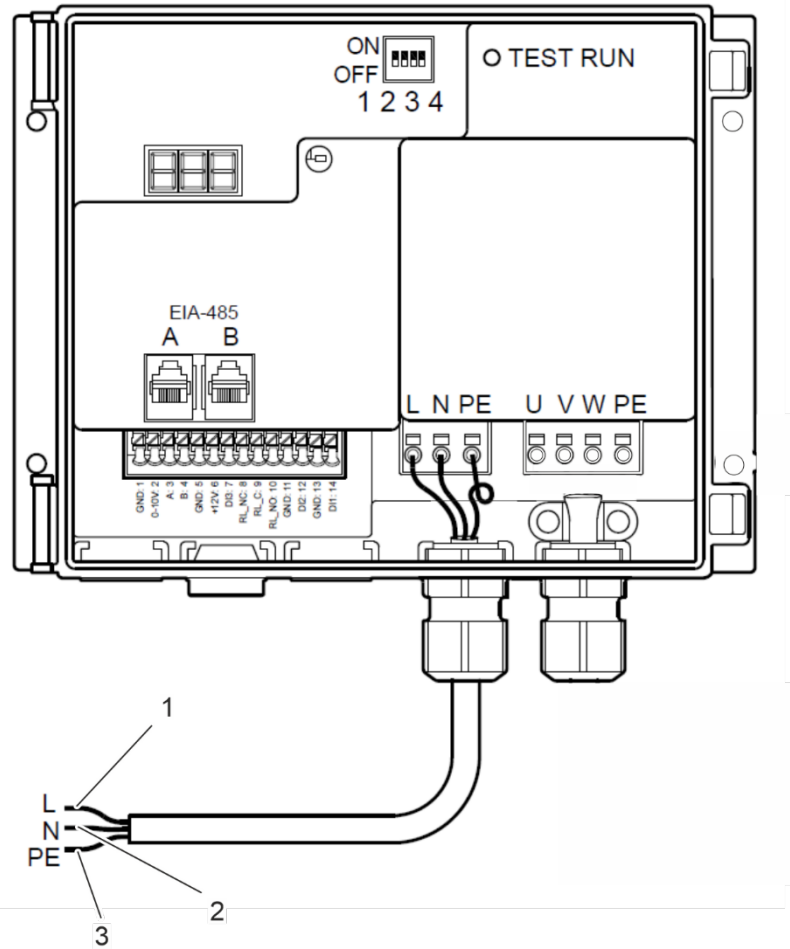

Fig. 97: Power supply wires

9. Connect phase wire (Fig. 97/1), neutral wire (Fig. 97/2) and protective wire (Fig. 97/3) to the voltage source.

Connect stepper motor

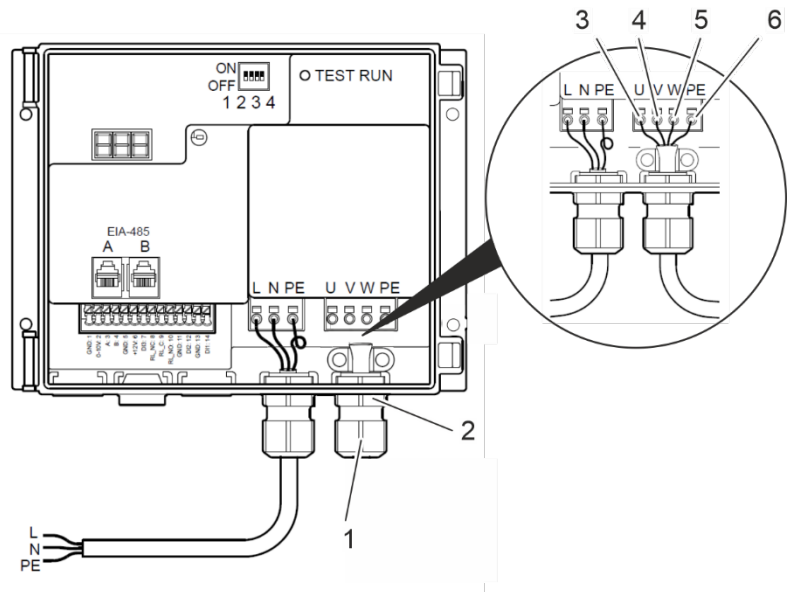

Fig. 98: Terminals stepper motor



Fig. 99: Motor cable

10. Loosen the nut (Fig. 98/1) of the cable entry (Fig. 98/2).
11. Slide the nut (Fig. 98/1) of the cable entry (Fig. 98/2) over the stepper motor extension cable.
12. Insert the wires (Fig. 99/1-4) of the stepper motor cable through the cable entry (Fig. 98/2) into the rotor cleaner drive.
13. Connect the brown wire (Fig. 99/3) to terminal U (Fig. 98/3).
14. Connect the black wire (Fig. 99/1) to terminal V (Fig. 98/4).
15. Connect the blue wire (Fig. 99/2) to terminal W (Fig. 98/5).
16. Connect the yellow-green wire (Fig. 99/4) to terminal PE (Fig. 98/6).
17. Secure the stepper motor extension cable in the cable entry (Fig. 98/2) by tightening the nut (Fig. 98/1).



The cables must be relieved against tension and torsion by the cable gland. Ensure that the cables are not already subjected to tension or torsion when tightening the nut.

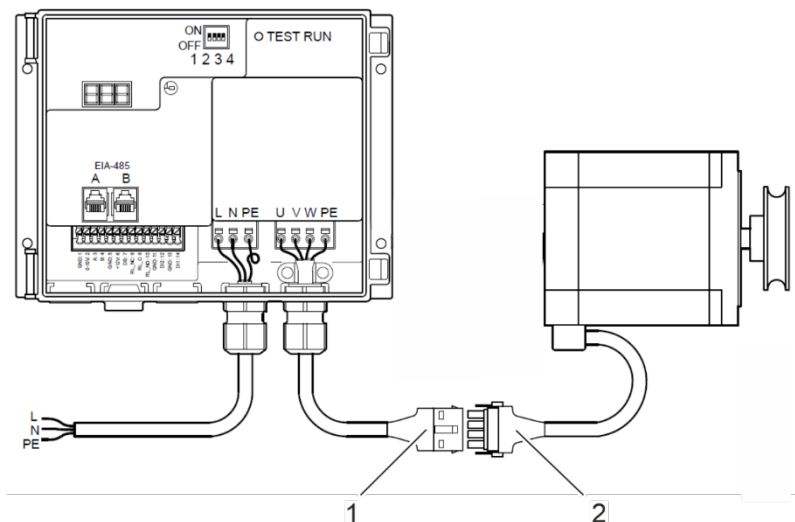

Fig. 100: Stepper motor cable connection

18. Connect the stepper motor extension cable (Fig. 100/1) to the stepper motor cable. (Fig. 100/2).



The cable connection is properly made when the pawls on both sides of the connector on the stepper motor cable are firmly connected to the sockets on the connector of the stepper motor extension cable.

Establish equipotential bonding

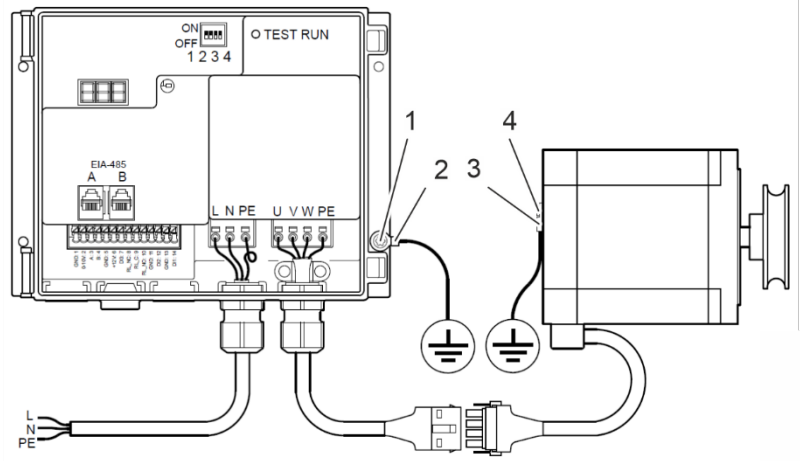

Fig. 101: Equipotential bonding

19. Fasten the potential equalization of the rotor cleaner drive with a ring cable lug (Fig. 101/2) to the housing of the rotor cleaner drive. To do this, use one of the holes (Fig. 101/1) that are used to attach the rotor cleaner drive to the housing of the rotary heat exchanger.



When designing the equipotential bonding, it is essential to follow the applicable local and national regulations, laws and ordinances.

20. Fasten the potential equalization of the stepper motor with a ring cable lug (Fig. 101/4) to the stepper motor. To do this, use the M3 hole (Fig. 101/3) on the backside of the stepper motor.



When designing the equipotential bonding, it is essential to follow the applicable local and national regulations, laws and ordinances.

Connect clock sensor

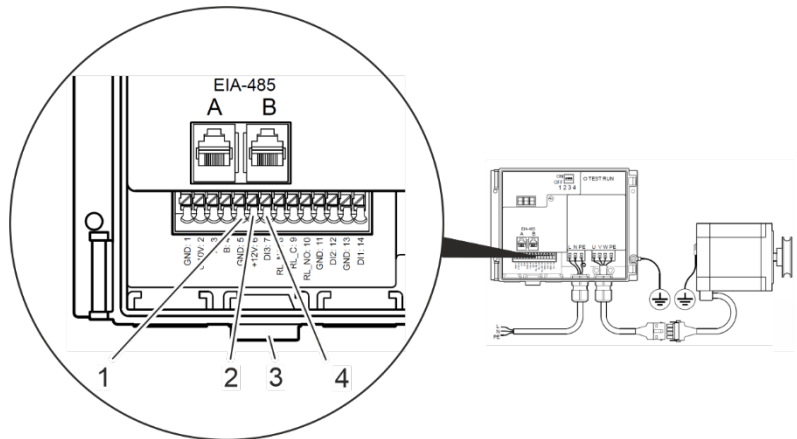

Fig. 102: Terminals clock sensor

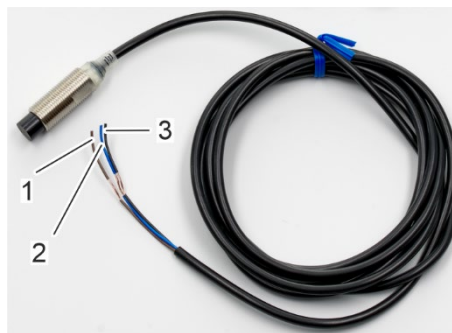

Fig. 103: Clock sensor cable

21. Insert the wires of the clock sensor (Fig. 103/1-3) through the cable entry (Fig. 102/3) into the rotor cleaner drive.
22. Connect the blue wire (Fig. 103/2) to terminal 5 (Fig. 102/1, GND).
Connect the brown wire (Fig. 103/1) to terminal 6 (Fig. 102/2, +12V).
23. Connect the black wire (Fig. 103/3) to terminal 7 (Fig. 102/4, DI3).
- 24.

Connect modbus cable

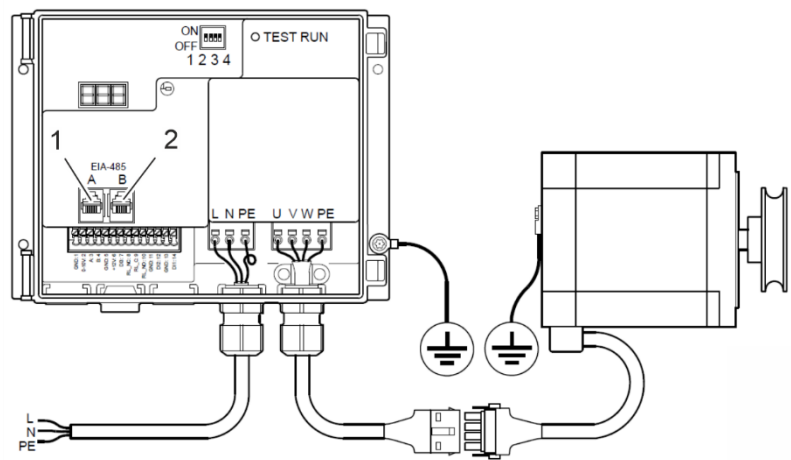

Fig. 104: Internal modbus connection via RJ12 connector



Fig. 105: Modbus cable RJ12 connector

25. Connect the modbus cable via the RJ 12 connector (Fig. 105/1) to RJ12 sockets A (Fig. 104/1).



When installing the RJ12 connectors, note that the connectors must be aligned so that the colour sequence in the connectors is the same at both cable ends. Connectors A and B are internally parallel connected and it is therefore optional which connector is used.

Close front cover

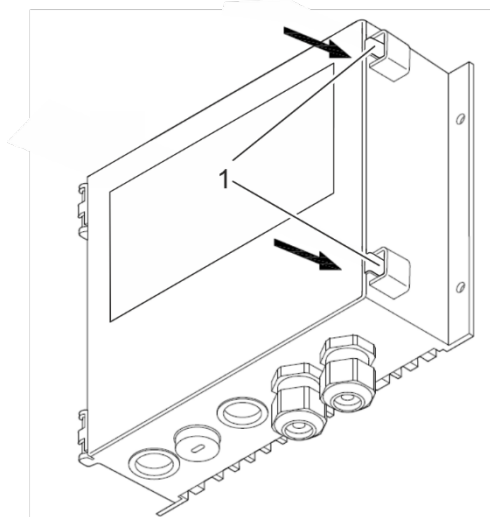

Fig. 106: Close front cover

26. Close the front cover of the rotor cleaner drive. Make sure that the locking clips (Fig. 106/1) engage audibly.

7. Commissioning and operation

7.1. Menu structure and menu navigation

Menu structure

The menu of the control software is structured hierarchically. The menu consists of a main menu from which several submenus can be selected. The individual menu items are numbered consecutively.

The menu is structured as follows:

- Home screen
- 1 Main menu
- 2 Setup
 - 21 Language
 - 22 Carriage stepsize
 - 23 Maximum rotor speed
 - 24 Minimum rotor speed
 - 25 Length tolerance
 - 26 Drying cycles
 - 27 Calibration
 - 28 Hardware test
- 3 Scheduler
 - 311 Set schedule
 - 321 Set date and time
- 4 Status
 - 41 Software versions
 - 42 System info
 - 43 Input signals
 - 44 Output signals
- 5 Alarms
 - 51 Active alarms
 - 52 Alarms

Some menus offer the functions Back and Exit. Selecting Back brings you to the previous menu. Selecting Exit exits the menu navigation and takes you to the home screen.

The control software is operated via the control panel with a display (Fig. 107/1) and 3 pushbuttons (Fig. 107/2 to Fig. 107/4) on the rotor cleaner control.

The currently selected menu, the setting options and the functions of the buttons are shown on the display (Fig. 107/1).

The function of the buttons (Fig. 107/2 to Fig. 107/4) varies depending on the menu currently selected. The specific function of the buttons (Fig. 107/2 to Fig. 107/4) is shown in the description of the individual submenus.

Menu navigation

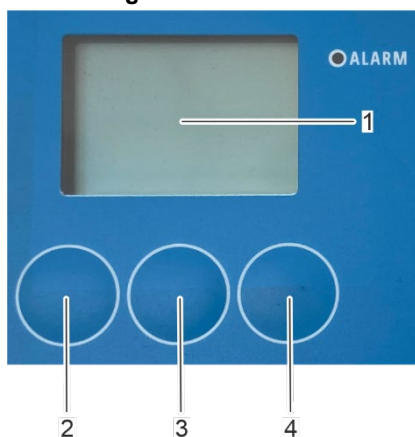

Fig. 107: Display and buttons of the rotor cleaner control

7.2. Basic settings and calibration

Set language

Personnel qualification:

- User

Pre-conditions:

- The cleaning rail is installed.
- The rotor cleaner drive is installed and connected to the power supply.
- All necessary electrical connections between the cleaning rail, the rotor cleaner drive and the rotor cleaner control are installed.
- The rotor cleaner control is connected to the power supply



After switching on the Rotor Cleaner Control, the basic settings, such as language, date and time, are made and the rotor cleaning device is calibrated.

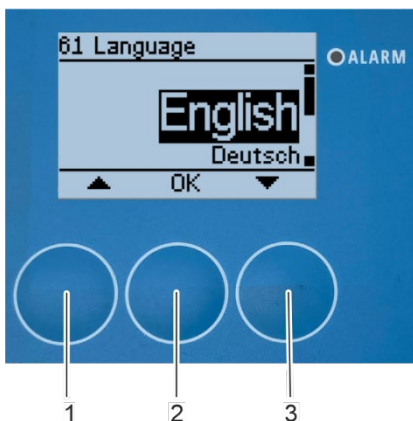

Fig. 108: Language selection

1. Use the arrow keys [up] (Fig. 108/1) and [down] (Fig. 108/3) to select the desired language.

2. Confirm the selection with [OK] (Fig. 108/2).

⇒ The "Set date and time" submenu appears (Fig. 109).

Set date and time

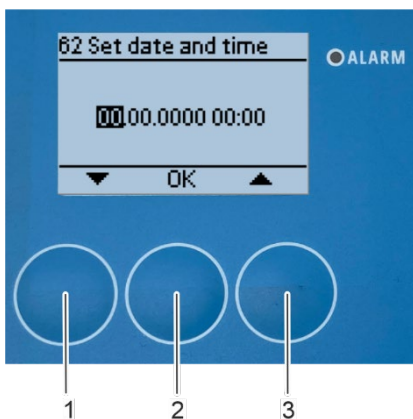

Fig. 109: Set day of month

3. Set the day of the month using the arrow keys [up] (Fig. 109/3) and [down] (Fig. 109/1)

4. Confirm the selection with [OK] (Fig. 109/2).

⇒ The submenu switches further to the setting of the month.



Make the month, year and time settings in the same way as the day setting.

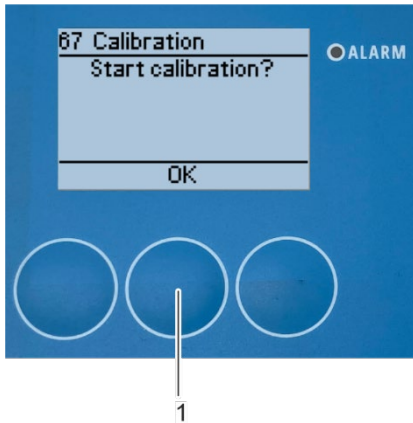

Fig. 110: Start calibration

5. Start the calibration with [OK] (Fig. 110/1).

⇒ The calibration status indicator appears, showing the actual status of the calibration (Fig. 111/1).

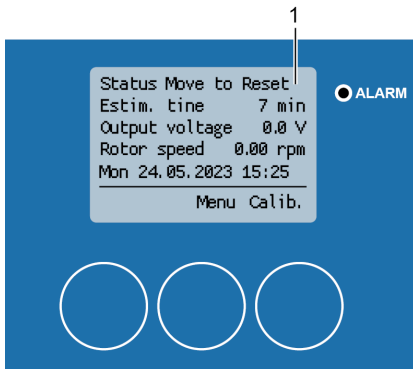

Fig. 111: Calibration status - move to reset

⇒ After the calibration has started, the cleaning carriage first moves to its starting position on the rotor circumference (Fig. 111/1).

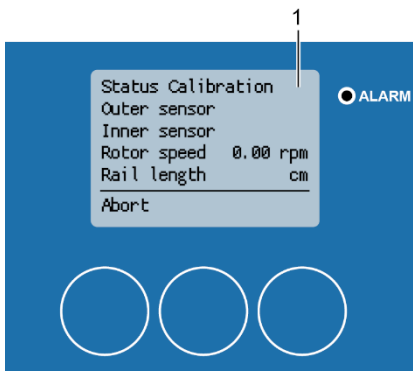

Fig. 112: Calibration process running

⇒ After the cleaning carriage has reached its starting position on the rotor circumference, the actual calibration process of the rotor cleaning device begins. The calibration status indicator shows „Calibration” (Fig. 112/1).

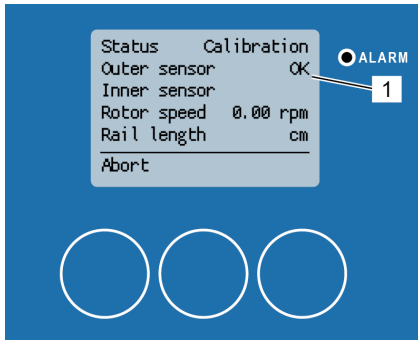

Fig. 113: Calibration outer sensor check

⇒ The cleaning carriage then moves to the centre of the rotor. After detecting a signal from the rotor circumference proximity sensor, the display shows “Outer Sensor OK” (Fig. 113/1).

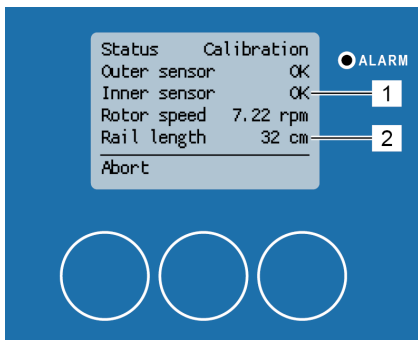

Fig. 114: Calibration inner sensor check

⇒ As soon as the cleaning carriage has reached the centre of the rotor and has detected a signal from the rotor centre proximity sensor, the display shows “Inner sensor OK” (Fig. 114/1). The calculated cleaning rail length is also displayed under “Rail length” (Fig. 114/2). The cleaning carriage then moves back to its starting position on the circumference of the rotor.

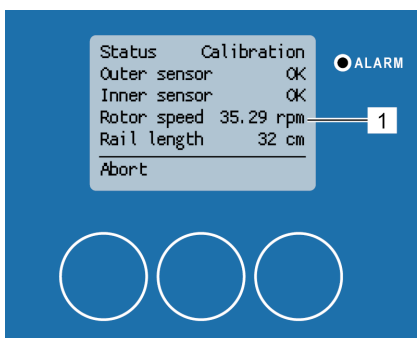

Fig. 115: Calibration maximum rotor speed

⇒ As soon as the cleaning carriage has reached its starting position, the rotor is accelerated to its maximum speed (Fig. 115/1).

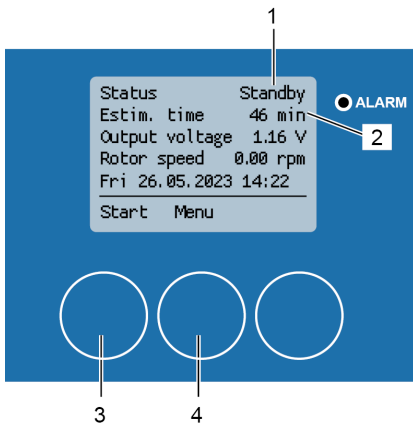

Fig. 116: Calibration complete

⇒ Once the maximum rotor speed is reached, the calibration is complete. The rotor slows down to a standstill and the display shows the status “Standby” (Fig. 116/1) and the calculated estimated cleaning time (Fig. 116/2). Now the cleaning can be started via [Start] (Fig. 116/3) or the “1 Main menu” menu can be called up via [Menu] (Fig. 116/4).

Abort the calibration

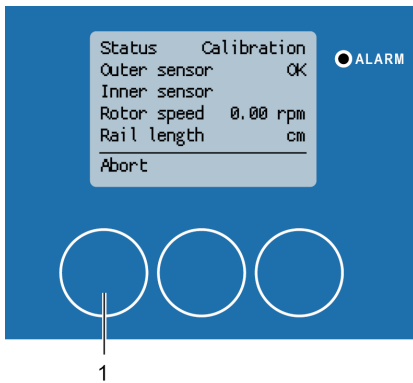

Fig. 117: Abort calibration

1. Press [Abort] (Fig. 117/1) to abort the calibration. The calibration process stops and the status indication shows “Standby” (Fig. 118/1)

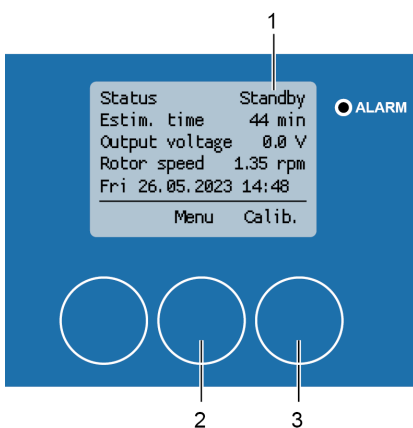

Fig. 118: Calibration aborted

2. Press [Menu] (Fig. 118/2) to open the “1 Main menu” menu or [Calib.] (Fig. 118/3) to restart the calibration.



The calibration can be aborted at any time during the calibration process. If the calibration is restarted via [Calib.] (Fig. 118/3), the cleaning carriage initially moves back to its starting position. The calibration then starts again. The calibration is mandatory. Otherwise, no entry screen for cleaning appears and cleaning cannot be started.

7.3. Settings

7.3.1. Open submenu “setup”

Open submenu “setup”

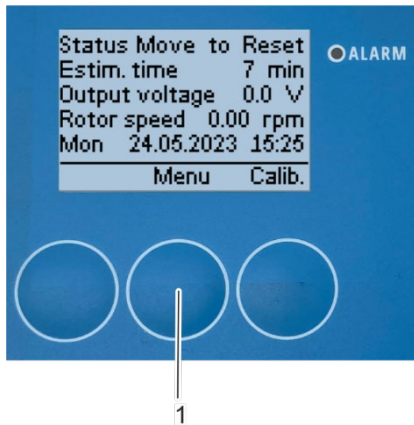

Fig. 119: Open main menu

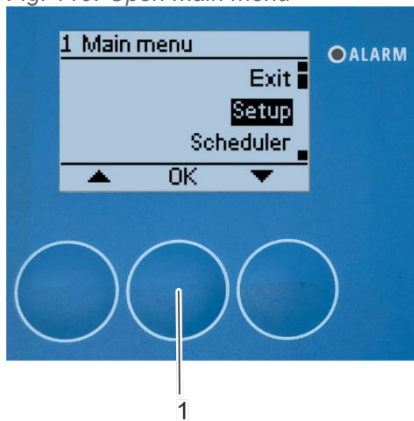

Fig. 120: Select submenu “Setup”

Personnel qualification:

- User

Pre-conditions:

- The cleaning rail is installed.
- The rotor cleaner drive is installed and connected to the power supply.
- All necessary electrical connections between the cleaning rail, the rotor cleaner drive and the rotor cleaner control are installed.
- The rotor cleaner control is connected to the power supply.
- The basic settings have been made and the calibration is complete.

1. Press *[Menu]* (Fig. 119/1) to open the “1 Main menu” menu (Fig. 120).

⇒ The “1 Main menu” menu appears on the display (Fig. 120).

2. Select the “Setup” submenu and confirm with *[OK]* (Fig. 120/1).

⇒ The display shows “Please enter password” (Fig. 121/1).

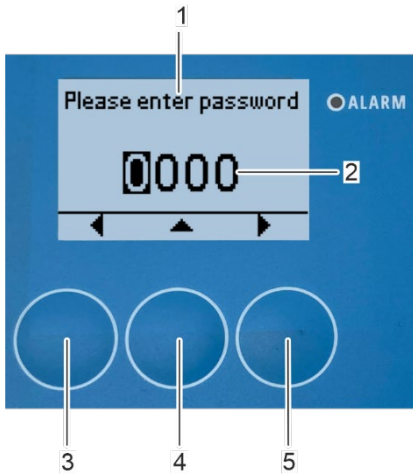

Fig. 121: Enter password

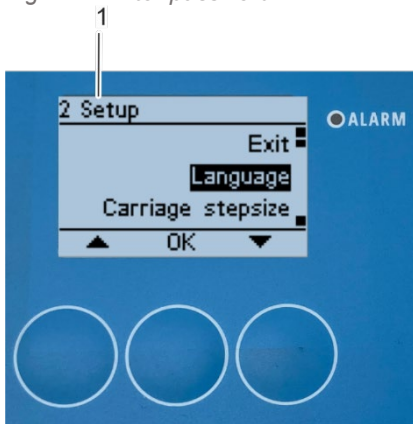

Fig. 122: Submenu „2 Setup“

3. Enter the password (Fig. 121/2) by using the arrow keys [up] (Fig. 121/4), [left] (Fig. 121/3) and [right] (Fig. 121/5).



The password to be entered is “1112”. The password is factory set and cannot be changed.

4. Use the arrow key [right] (Fig. 121/5) after you have selected the last password digit.

⇒ The “2 Setup” submenu appears on the display (Fig. 122/1).

7.3.2. Change language

Change language

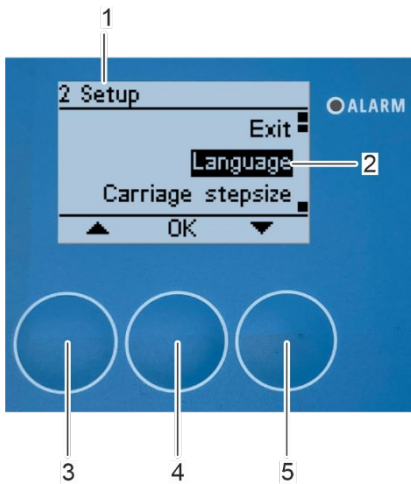

Fig. 123: Select submenu "language"

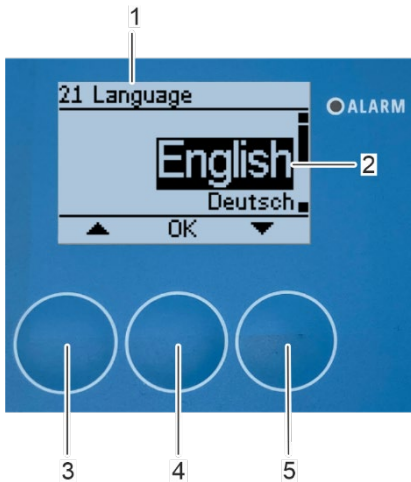

Fig. 124: Set language

Pre-condition:

- The "2 Setup" submenu is open.

1. Select the "Language" submenu (Fig. 123/2) with the arrow keys [up] (Fig. 123/3) and [down] (Fig. 123/5).

2. Confirm the selection with [OK] (Fig. 123/4).

⇒ The "21 Language" submenu appears on the display (Fig. 124/1)

3. Select the preferred language (Fig. 124/2) with the arrow keys [up] (Fig. 124/3) and [down] (Fig. 124/5).

4. Confirm the selection with [OK] (Fig. 124/4).

⇒ The "2 Setup" submenu appears on the display again (Fig. 125/1).

7.3.3. Set carriage step size

Set carriage stepsize

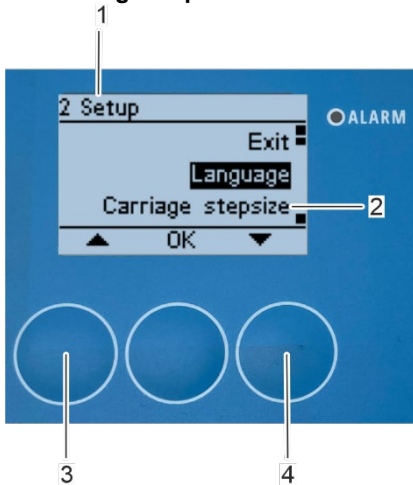

Fig. 125: Select submenu "carriage stepsize"



Fig. 126: Open submenu "carriage stepsize"

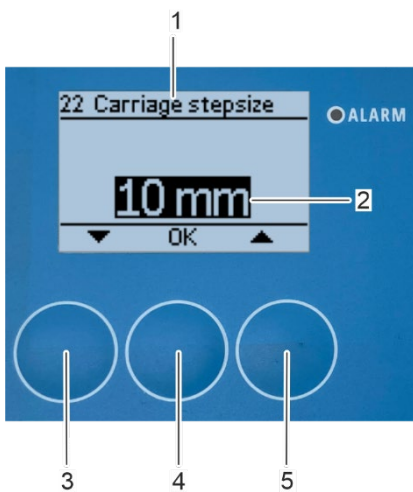

Fig. 127: Set carriage stepsize

1. Select the "Carriage stepsize" submenu (Fig. 125/2) with the arrow keys [up] (Fig. 125/3) and [down] (Fig. 125/4).

2. Open the "Carriage stepsize" submenu with [OK] (Fig. 126/1).

⇒ The "22 Carriage stepsize" submenu appears on the display (Fig. 127/1).

3. Set the carriage step size with the arrow keys [up] (Fig. 127/5) and [down] (Fig. 127/3).



The step size describes the feed of the cleaning carriage per rotor revolution. The step size is preset to 10 mm to achieve an optimum cleaning result taking into account the spray cone of the water nozzle. Change this value only if an area-wide cleaning result is not achieved or if the properties of the water nozzle change as part of a replacement. The step size can be set within a range from 5 to 30 mm. After a change has been made, a new calibration must be performed.

4. Confirm the selection with [OK] (Fig. 127/4).

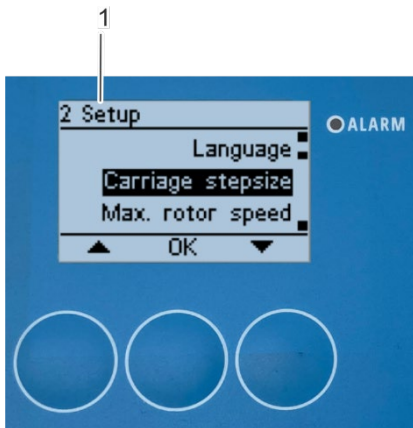

Fig. 128: Submenu "2 setup"

⇒ The "2 setup" submenu appears on the display again (Fig. 128/1).

7.3.4. Set maximum rotor speed

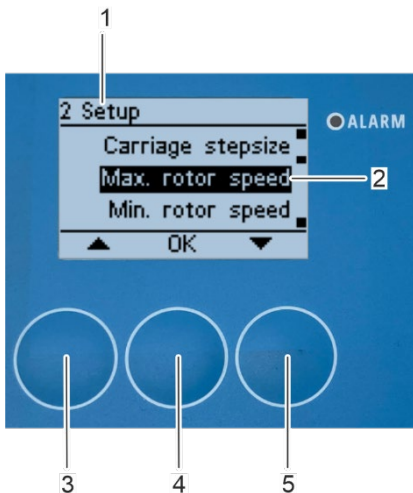

Fig. 129: Open submenu "maximum rotor speed"

1. Select the "Max. rotor speed" submenu (Fig. 129/2) with the arrow keys [up] (Fig. 129/3) and [down] (Fig. 129/5) in "2 Setup" submenu (Fig. 129/1).

2. Confirm the selection with [OK] (Fig. 129/4).

⇒ The "23 Max. rotor speed" submenu appears on the display (Fig. 130/1).

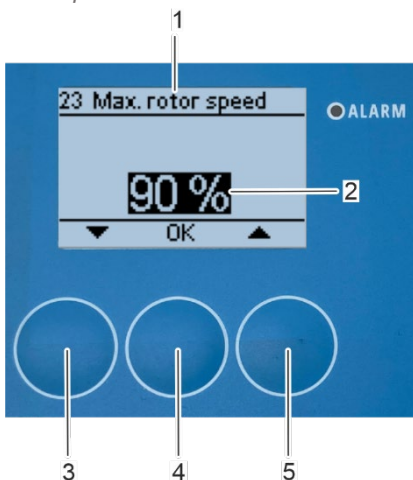

Fig. 130: Set maximum rotor speed

3. Set the maximum rotor speed (Fig. 130/2) with the arrow keys [up] (Fig. 130/5) and [down] (Fig. 130/3).



The maximum rotor speed can be set within a range from 50 to 100 %. The maximum rotor speed is preset to 90 %. Increase this value only if you find that you also achieve a satisfactory cleaning result with a higher maximum rotor speed. Decrease this value only if the cleaning result is not satisfactory. After a change has been made, a new calibration must be performed

4. Confirm the selection with [OK] (Fig. 130/4).

⇒ The "2 Setup" submenu appears on the display again (Fig. 131/1).

7.3.5. Set minimum rotor speed

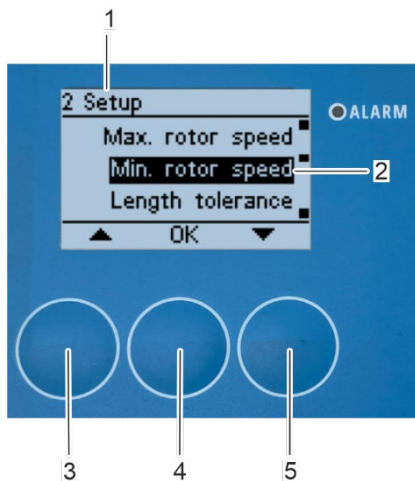

Fig. 131: Open submenu "minimum rotor speed"

1. Select the "Min. rotor speed" submenu (Fig. 131/2) with the arrow keys [up] (Fig. 131/3) and [down] (Fig. 131/5) in "2 Setup" submenu (Fig. 131/1).
2. Confirm the selection with [OK] (Fig. 131/4).

⇒ The "24 Min. rotor speed" submenu appears on the display (Fig. 132/1).

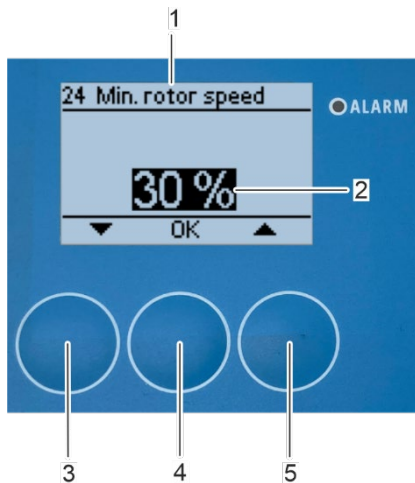

Fig. 132: Set minimum rotor speed

3. Set the minimum rotor speed (Fig. 132/2) with the arrow keys [up] (Fig. 132/5) and [down] (Fig. 132/3).



The minimum rotor speed is preset to 30 % of the target speed at 10 V control signal. Change this value only if the cleaning performance is poor and adjusting all other parameters, such as pressure, temperature and, if necessary, cleaning additives, does not remedy the situation. Lower rotor speed increases cleaning time and water consumption. The minimum rotor speed can be set within a range from 0 to 50 %. After a change has been made, a new calibration must be performed

4. Confirm the setting with [OK] (Fig. 132/4).

⇒ The "2 Setup" submenu appears again on the display again (Fig. 133/1).

7.3.6. Set length tolerance

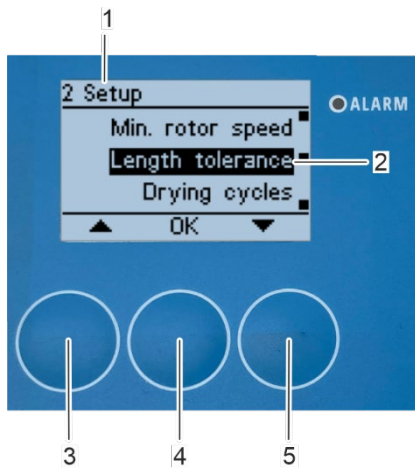

Fig. 133: Open submenu "length tolerance"

1. Select the "Length tolerance" submenu (Fig. 133/2) with the arrow keys [up] (Fig. 133/3) and [down] (Fig. 133/5) in "2 Setup" submenu (Fig. 133/1).
2. Confirm the selection with [OK] (Fig. 133/4).

⇒ The "25 Length tolerance" submenu appears on the display (Fig. 134/1).

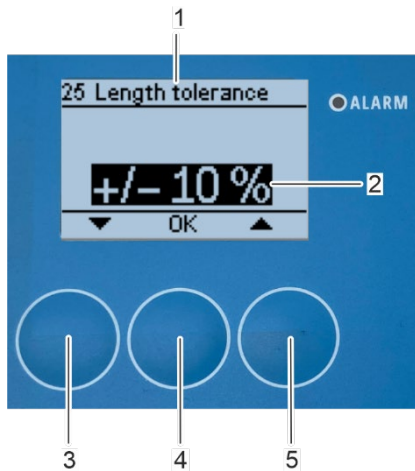

Fig. 134: Set length tolerance

3. Set the length tolerance (Fig. 134//2) with the arrow keys [up] (Fig. 134/5) and [down] (Fig. 134/3).



This value is used to mitigate any differences between the cleaning path measured during calibration and the actual rotor length to be cleaned. The length tolerance is preset to $\pm 10\%$. This setting is sufficient in most cases. Change this value only if the cleaning result is poor and changing the other parameters has not improved the cleaning result. The length tolerance can be set within a range from 0 % to $\pm 20\%$. After a change has been made, a new calibration must be performed.

4. Confirm the setting with [OK] (Fig. 134//4).

⇒ The "2 Setup" submenu appears on the display again (Fig. 135/1).

7.3.7. Set drying cycles

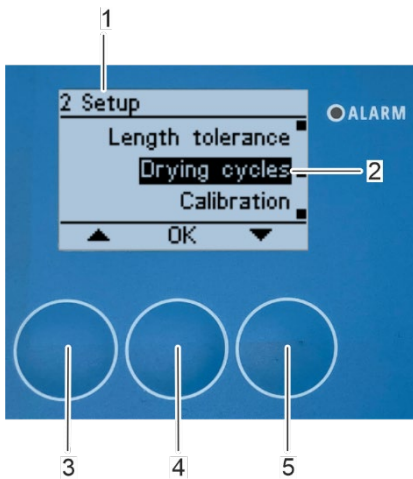

Fig. 135: Open submenu "drying cycles"

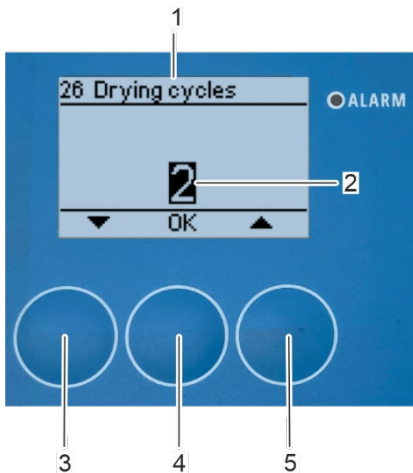

Fig. 136: Set drying cycles

1. Select the "Drying cycles" submenu (Fig. 135//2) with the arrow keys [up] (Fig. 135//3) and [down] (Fig. 135//5) in submenu "2 Setup" (Fig. 135//1).
2. Confirm the selection with [OK] (Fig. 135//4).

⇒ The "26 Drying cycles" submenu appears on the display (Fig. 136/1).

3. Set the drying cycles (Fig. 136/2) with the arrow keys [up] (Fig. 136/5) and [down] (Fig. 136/3).



The drying cycles determine how often the cleaning section is run down with compressed air during cleaning operation. The drying cycles are preset to a value of 2. Increase this value only if the residual water content in the rotor matrix is too high after passing through the preset number of drying cycles. Reduce this value only if the rotor matrix is sufficiently dry after passing through a lower number of drying cycles than the preset one. The drying cycles can be set within a range 1 to 4. After a change has been made, a new calibration must be performed

4. Confirm the setting with [OK] (Fig. 136/4).

⇒ The "2 Setup" submenu appears on the display again (Fig. 137/1).

7.3.8. Perform calibration

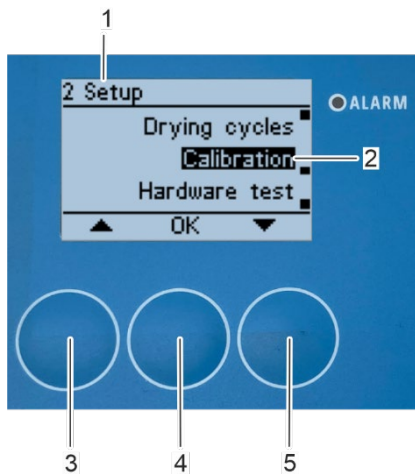

Fig. 137: Open submenu „Calibration“

1. To perform a renewed calibration, select the “*Calibration*” submenu (Fig. 137/2) with the arrow keys *[up]* (Fig. 137/3) and *[down]* (Fig. 137/5) in “2 Setup” submenu (Fig. 137/1).

2. Confirm the selection with *[OK]* (Fig. 137/4).

⇒ The “27 Calibration” submenu appears on the display (Fig. 138/1).

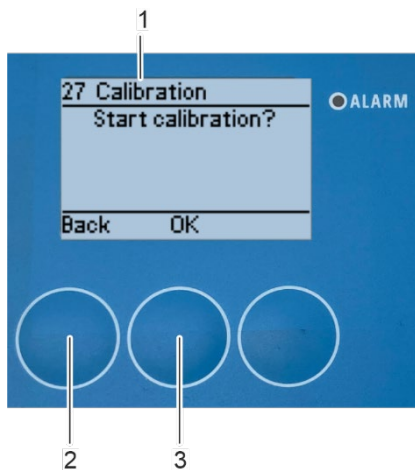

Fig. 138: Perform calibration

3. Confirm calibration start with *[OK]* (Fig. 138/3).



To not carry out the calibration and exit the submenu, press *[Back]* (Fig. 138/2).

⇒ The calibration is carried out ↪ *chapter Basic settings and calibration on page 80.*

7.3.9. Perform hardware test

Open submenu "Hardware test"

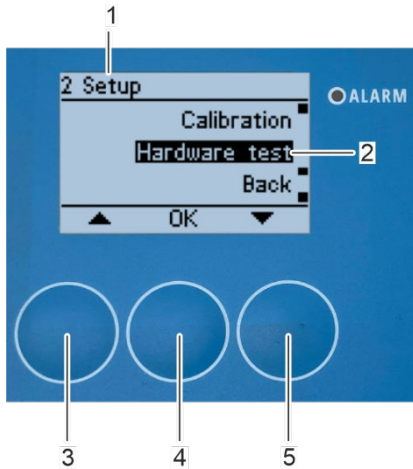

Fig. 139: Open submenu "hardware test"

1. Select the "Hardware test" submenu (Fig. 139/2) with the arrow keys [up] (Fig. 55/3) and [down] (Fig. 139/5) in "2 Setup" submenu (Fig. 139/1).
2. Confirm the selection with [OK] (Fig. 139/4).

⇒ The "28 Hardware test" submenu (Fig. 140/1) appears on the display.

Check 0-10V output

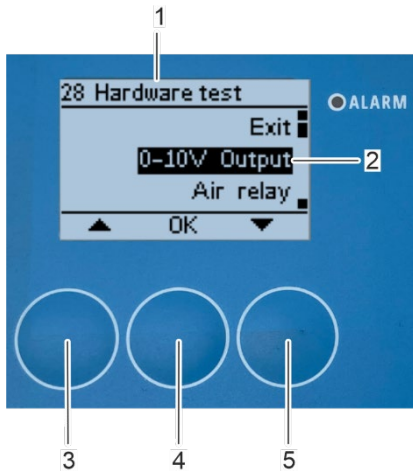

Fig. 140: Open submenu "0-10V output"

1. Select the "0-10V Output" submenu (Fig. 140/2) with the arrow keys [up] (Fig. 140/3) and [down] (Fig. 140/5).
2. Confirm the selection with [OK] (Fig. 140/4).

⇒ The "281 0-10V Output" submenu (Fig. 141/1) appears on the display.

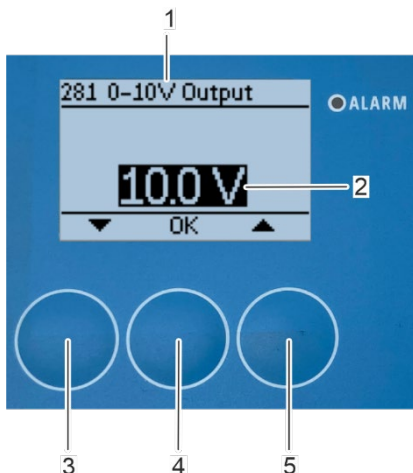

Fig. 141: Set 0-10 V output signal

3. Set the output voltage (Fig. 141/2) with the arrow keys [up] (Fig. 141/5) and [down] (Fig. 141/3).



The voltage output signal can be set within a range from 0 – 10 V. A voltage signal of 0 V corresponds to the rotor standing still. A voltage signal of 10 V corresponds to a rotation at maximum speed.

4. Confirm the selection with [OK] (Fig. 141/4).

⇒ The “28 Hardware test” submenu (Fig. 142/1) appears on the display again and the rotor turns when the electrical installation is correct.



The change in the resulting speed can be read on the control unit of the rotor. Alternatively, the voltage at the rotor control unit can be measured and compared with the set voltage signal.

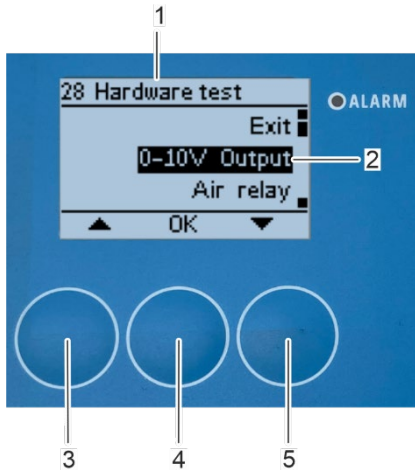

Fig. 142: Open submenu “0-10V output”

5. After checking the 0-10 V output, select the “0-10V Output” submenu (Fig. 142/2) and confirm with [OK] (Fig. 142/4).

⇒ The “281 0-10V Output” submenu (Fig. 143/1) appears on the display.

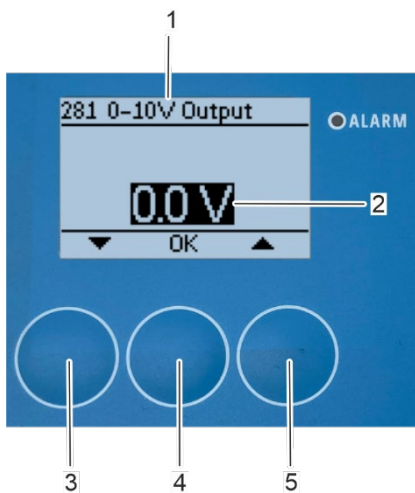

Fig. 143: Set voltage output signal to 0 V

6. Reset the voltage signal to 0 V (Fig. 143/2) with the arrow keys [up] (Fig. 143/5) and [down] (Fig. 143/3).
7. Confirm the setting with [OK] (Fig. 143/4).

⇒ The “28 Hardware test” submenu appears again on the display (Fig. 144/1) and the rotor slows down to a standstill.

Check compressed air relay

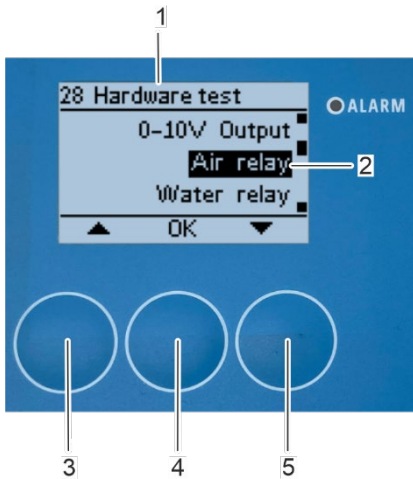

Fig. 144: Open submenu "air relay"

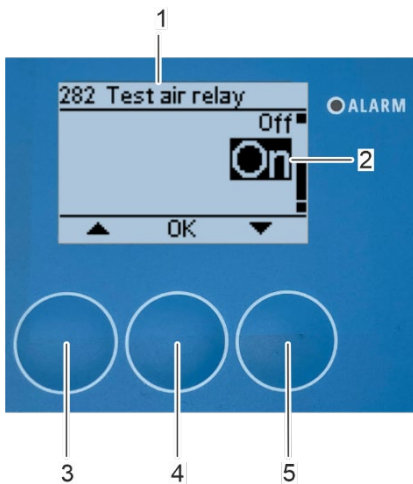

Fig. 145: Switch on compressed air relay

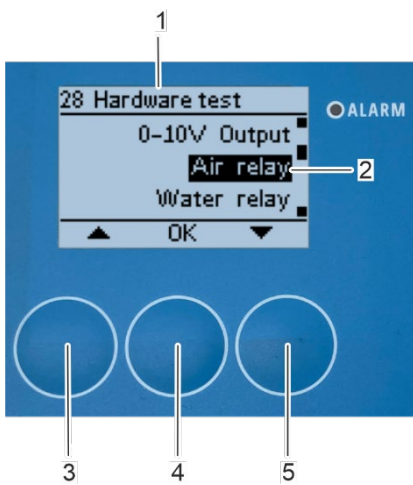

Fig. 146: Open submenu "air relay"

1. Select the "Air relay" submenu (Fig. 144/2) with the arrow keys [up] (Fig. 144/3) and [down] (Fig. 144/5).

2. Confirm the selection with [OK] (Fig. 144/4).

⇒ The "282 Test air relay" submenu (Fig. 145/1) appears on the display.

3. Select "On" (Fig. 145/2) with the arrow keys [up] (Fig. 145/3) and [down] (Fig. 145/5).

4. Confirm the selection with [OK] (Fig. 145/4).

⇒ The "28 Hardware test" submenu (Fig. 146/1) appears on the display again, the air relay closes and compressed air flows out of the compressed air nozzle if the electrical and mechanical installation is correct.

5. After checking the compressed air relay, open the "Air relay" submenu (Fig. 146/2) again with [OK] (Fig. 146/4).

⇒ The "282 Test air relay" submenu (Fig. 147/1) appears on the display.

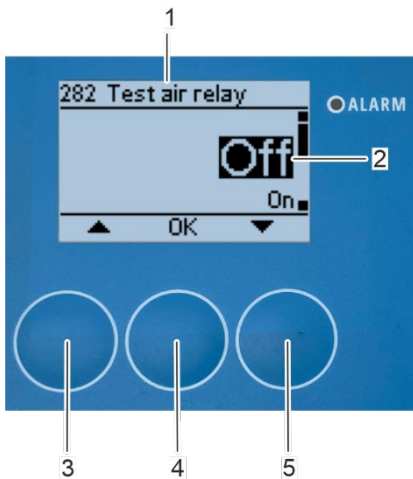

Fig. 147: Switch off compressed air relay

6. Select "Off" (Fig. 147/2) with the arrow keys [up] (Fig. 147/3) and [down] (Fig. 147/5).
7. Confirm the selection with [OK] (Fig. 147/4).

⇒ The "28 Hardware test" submenu (Fig. 148/1) appears again on the display, the air relay opens and compressed air no longer flows out of the compressed air nozzle.

Check water relay

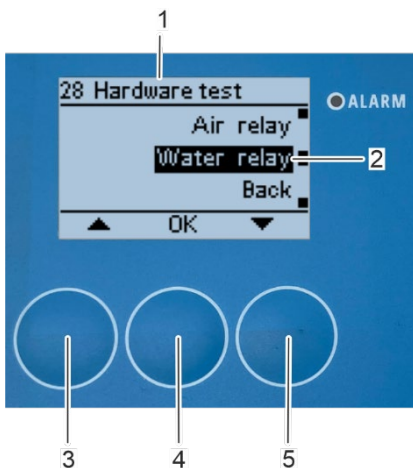

Fig. 148: Open submenu "water relay"

1. Select the "Water relay" submenu (Fig. 148/2) with the arrow keys [up] (Fig. 148/3) and [down] (Fig. 148/5).
2. Confirm the selection with [OK] (Fig. 148/4).

⇒ The "283 Test water relay" submenu (Fig. 149/1) appears on the display.

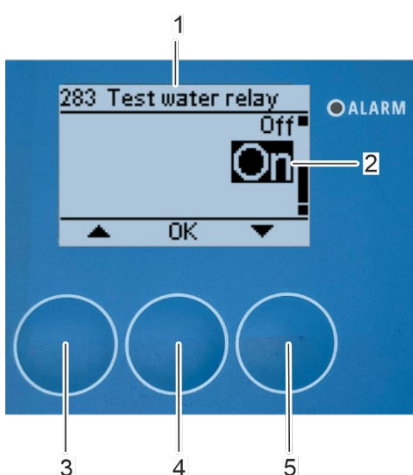

Fig. 149: Switch on water relay

3. Select "On" (Fig. 149/2) with the arrow keys [up] (Fig. 149/3) and [down] (Fig. 149/5).
4. Confirm the selection with [OK] (Fig. 149/4).

⇒ The "28 Hardware test" submenu (Fig. 150/1) appears on the display again, the water relay closes and water flows out of the high-pressure hot water nozzle.

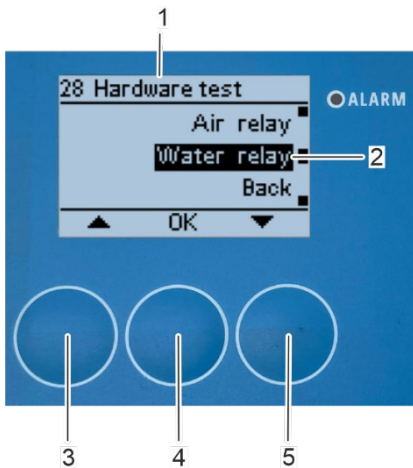

Fig. 150: Open submenu "water relay"

5. After checking the water relay, open the "Water relay" submenu (Fig. 150/2) again with [OK] (Fig. 150/4).

⇒ The "283 Test water relay" submenu (Fig. 151/1) appears on the display.

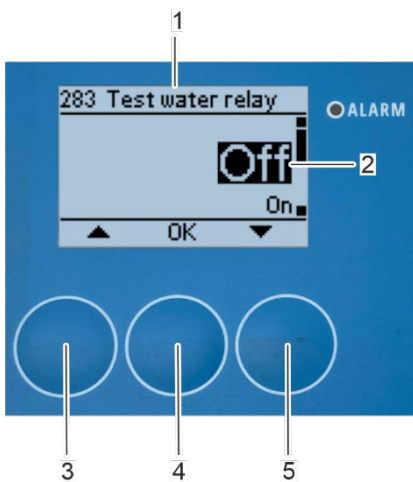

Fig. 151: Switch off water relay

6. Select "Off" (Fig. 151//2) with the arrow keys [up] (Fig. 151//3) and [down] (Fig. 67/5).

7. Confirm the selection with [OK] (Fig. 151//4).

⇒ The "28 Hardware test" submenu appears on the display again, the water relay opens and water no longer flows out of the high-pressure hot water nozzle.

7.4. Scheduler



The scheduler enables automatic cleaning on preselected days of the week.

Open scheduler submenu

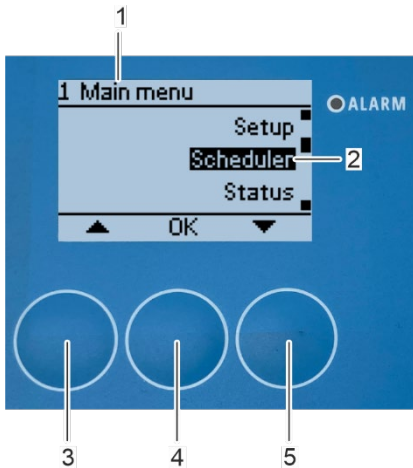

Fig. 152: Open "Scheduler" submenu

1. Select the "Scheduler" submenu (Fig. 152/2) in "1 Main menu" menu (Fig. 152/1) with the arrow keys [up] (Fig. 152/3) and [down] (Fig. 152/5).
2. Confirm the selection with [OK] (Fig. 152/4).

⇒ The "3 Scheduler" submenu (Fig. 153/1) appears on the display.

Set scheduler

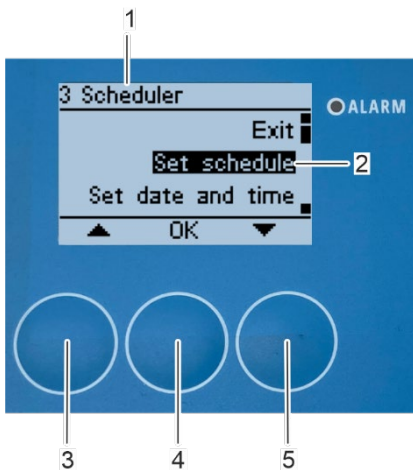

Fig. 153: Open „Set schedule“ submenu

3. Select the "Set schedule" submenu (Fig. 153/2) with the arrow keys [up] (Fig. 153/3) and [down] (Fig. 153/5).
4. Confirm the selection with [OK] (Fig. 153/4).

⇒ The "311 Set schedule" submenu (Fig. 154/1) appears on the display.

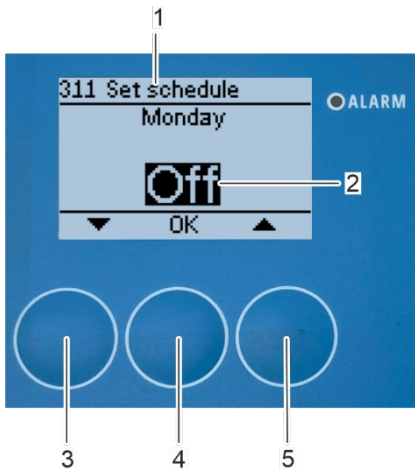

Fig. 154: Select the days for automatic cleaning

5. Press the arrow key *[up]* (Fig. 154/5) on the days you want the rotor cleaning device to perform an automatic cleaning.



If the rotor cleaning device shall not perform an automatic cleaning on the selected day confirm the selection [Off] (Fig. 154/2) with [OK] (Fig. 154/4). The display switches to the next day of the week.

⇒ The selection of the start time appears on the display (Fig. 155/1).

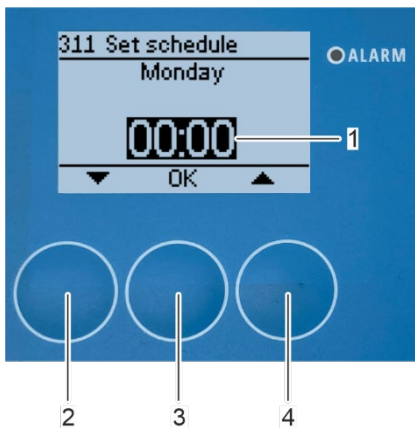

Fig. 155: Select start time for automatic cleaning

6. Select the start time for automatic cleaning with the arrow keys *[up]* (Fig. 155/4) and *[down]* (Fig. 155/2).



The time is set in 24-hours format.

7. Confirm the selection with *[OK]* (Fig. 155/3).

⇒ The display switches to the next day of the week.

Set date and time



The date and time must be set in the rotor cleaner control so that the scheduler can be used. If the date and time has already been set in the basic settings ↗ chapter 7.2 Basic settings and calibration on page 80, the following steps do not need to be performed.

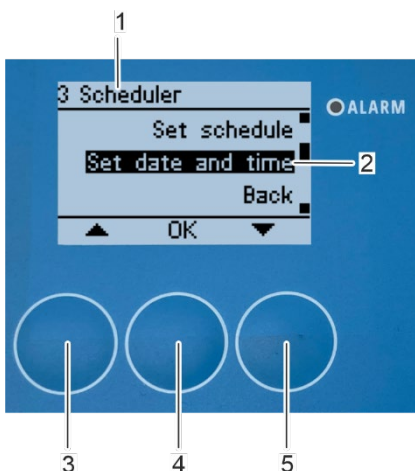

Fig. 156: Open "Set date and time" submenu

8. Select the "Set date and time" submenu (Fig. 156/2) in "3 Scheduler" submenu (Fig. 156/1) with the arrow keys *[up]* (Fig. 156/3) and *[down]* (Fig. 156/5).

9. Confirm the selection with *[OK]* (Fig. 156/4).

⇒ The "321 Set date and time" submenu (Fig. 157/1) appears on the display

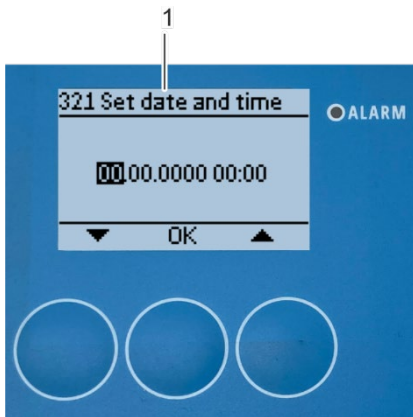

Fig. 157: "Set date and time" submenu

10. Set the actual date and time analogous to [chapter 7.2 Basic settings and calibration on page 80](#).

7.5. Starting and stopping cleaning

Start the cleaning process

Requirements:

- The basic settings have been made and the calibration has been completed.



If the calibration has been carried out successfully, the cleaning process start screen appears on the display showing the status indication "Standby" (Fig. 158/1) and the estimated cleaning time (Fig. 158/2).

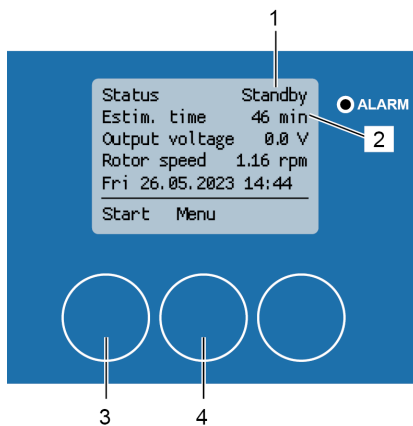

Fig. 158: Cleaning process start screen

1. Start the cleaning process with [Start] (Fig. 158/3).



Press [Menu] (Fig. 158/4) to return to "1 Main menu" menu.

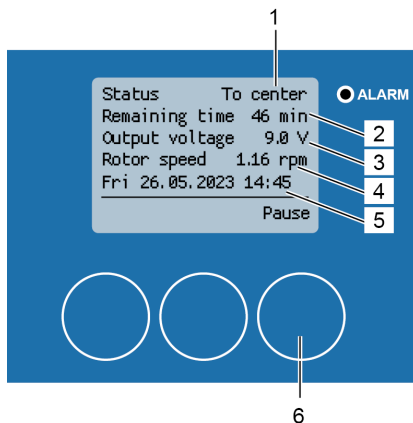

Fig. 159: Cleaning process status screen - Cleaning carriage moves to rotor centre

⇒ The cleaning process starts and the cleaning process status screen appears showing the actual status of the cleaning process (Fig. 159/1), the remaining cleaning time (Fig. 159/2), the actual output voltage (Fig. 159/3), the actual rotor speed (Fig. 159/4) and the date and time (Fig. 159/5).

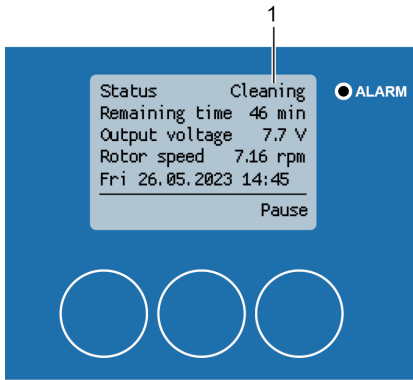

Fig. 160: Cleaning process status screen – cleaning

⇒ As soon as the cleaning carriage has reached the centre of the rotor, the water and air relay both close, the associated solenoid valves are released and the cleaning with water and compressed air begins. The status indication switches to “Cleaning” (Fig. 160/1).

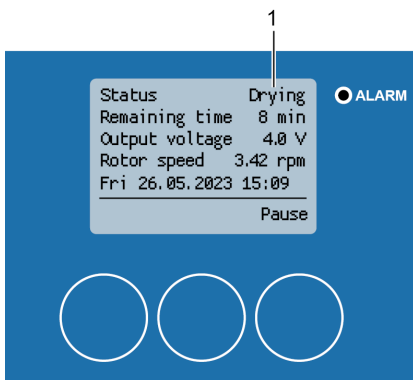

Fig. 161: Cleaning process status screen – drying

⇒ As soon as the cleaning carriage has reached the rotor circumference, the water relay opens and the cleaning carriage returns to the centre of the rotor with the compressed air still running to dry the rotor matrix. The status indication switches to “Drying” (Fig. 161/1).



The number of cleaning carriage runs with compressed air depends on the set drying cycle value.

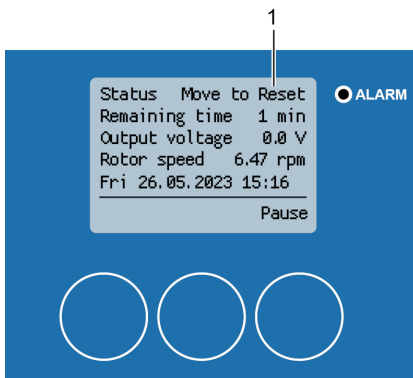

Fig. 162: Cleaning process status screen - move to reset

⇒ After reaching the centre of the rotor again, the cleaning carriage moves back to the starting position on the rotor circumference. The status indication switches to “Move to Reset” (Fig. 162/1).

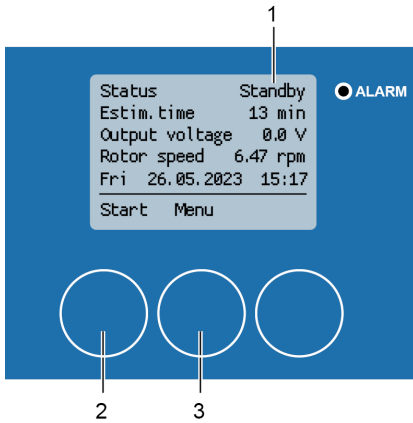

Fig. 163: Cleaning process start screen

⇒ After the cleaning carriage has reached its starting position on the rotor circumference, the cleaning process is complete. The status indication switches to “Standby” (Fig. 163//1).

2. Press [Start] (Fig. 163/2) to start the cleaning process again or [Menu] (Fig. 163/3) to open the “1 Main menu” menu.

Pause the cleaning process



The cleaning process can be paused at any time, regardless of the current carriage position.

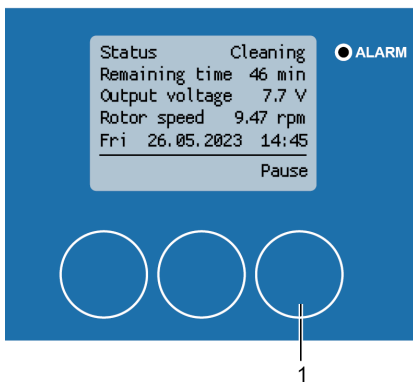

Fig. 164: Pause cleaning process

1. Press [Pause] (Fig. 164/1) to pause the cleaning process.

⇒ The cleaning carriage and the rotor stop and the functions “Abort” (Fig. 165/1) and “Resume” (Fig. 165/2) appear on the display.

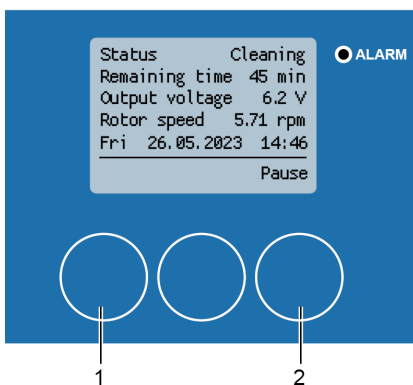

Fig. 165: Abort or resume cleaning process

Abort cleaning process

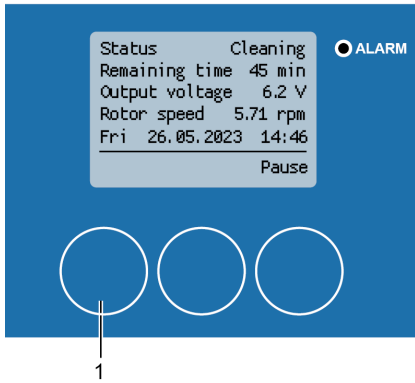

Fig. 166: Abort cleaning process

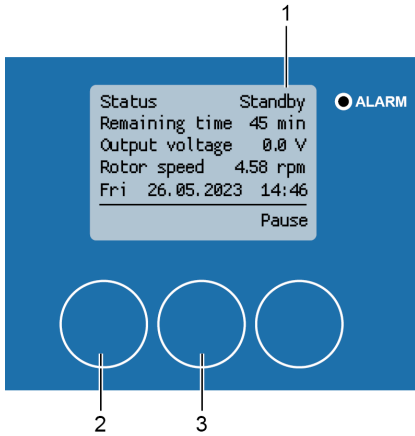

Fig. 167: Cleaning process start screen

Resume cleaning process

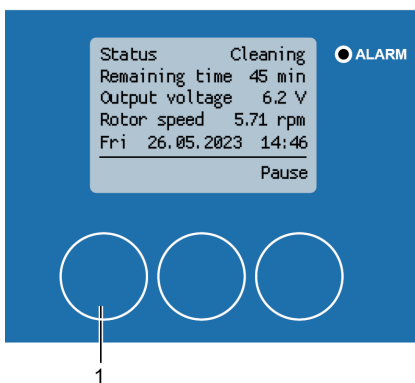

Fig. 168: Resume cleaning process

1. Press **[Abort]** (Fig. 166/1) to abort the cleaning process.

⇒ The cleaning process start screen appears on the display showing the status indication “Standby” (Fig. 167/1). Pressing **[Start]** (Fig. 167/2) restarts the cleaning process. Pressing **[Menu]** (Fig. 167/3) calls up the “1 Main menu” menu.



After restarting the cleaning, the cleaning carriage first moves to its starting position on the rotor circumference and then starts the cleaning process.

1. Press **[Resume]** (Fig. 168/1) to resume the cleaning process.

⇒ The cleaning process status screen appears again indicating the actual status (Fig. 169/1) of the cleaning process and the cleaning process starts again from its last position before pausing the process.



It is possible to pause the cleaning process and then continue cleaning from the last position of the cleaning carriage for up to one hour. If the cleaning process is paused for more than one hour, the cleaning process must be restarted.

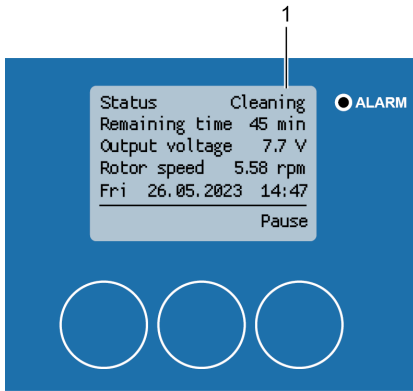

Fig. 169: Cleaning process status screen – cleaning

7.6. Status indicators

Open submenu “status”

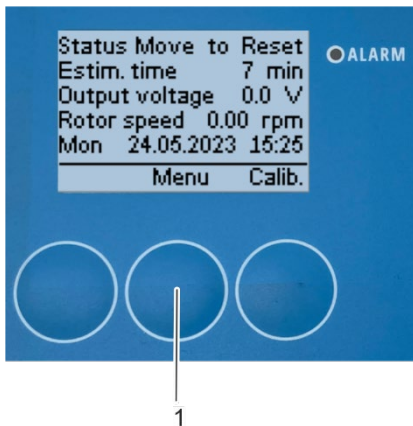

Fig. 170: Open main menu

1. Press [Menu] (Fig. 170/1) to open the “1 Main menu” menu (Fig. 171/1).
 ⇒ The “1 Main menu” menu appears on the display (Fig. 171/1).

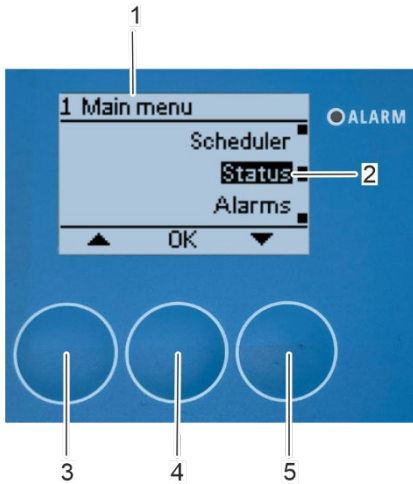

Fig. 171: Open submenu "Status"

2. Select the "Status" submenu (Fig. 171/2) with the arrow keys [up] (Fig. 171/3) and [down] (Fig. 171/5).
 3. Confirm the selection with [OK] (Fig. 171/4).
- ⇒ The "4 Status" submenu appears on the display (Fig. 172/1).

Open submenu "Software versions"

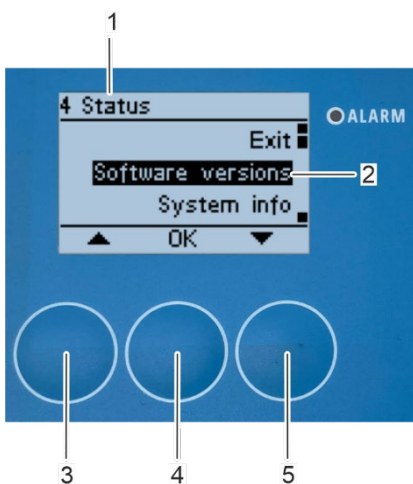

Fig. 172: Open submenu "Software versions"

1. Select the "Software versions" submenu (Fig. 172/2) with the arrow keys [up] (Fig. 172/3) and [down] (Fig. 172/5).
2. Confirm the selection with [OK] (Fig. 172/4).

⇒ The "41 Software versions" submenu appears on the display (Fig. 173/1) showing the actual software versions of the rotor cleaner control (Fig. 173/2) and the rotor cleaner drive (Fig. 173/3 and Fig. 173/4).

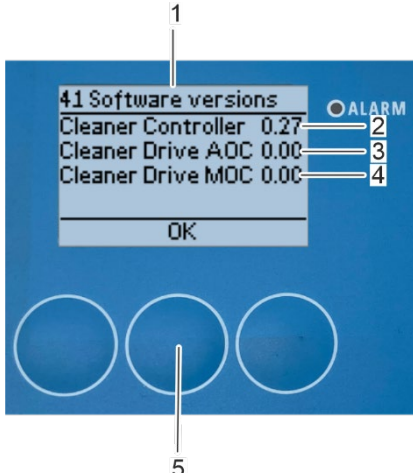

Fig. 173: Submenu "Software versions"

3. Press [OK] (Fig. 173/5) to return to the "4 Status" submenu (Fig. 174/1).
- ⇒ The "4 Status" submenu appears on the display (Fig. 174/1).

Open submenu "System info"

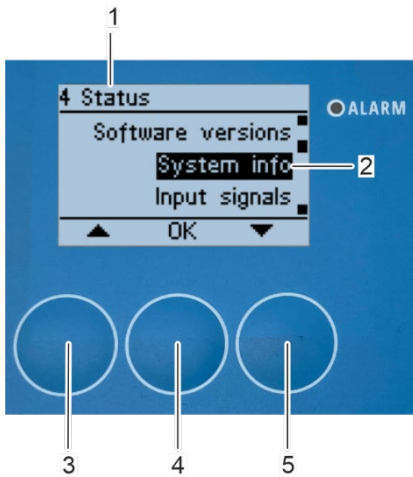

Fig. 174: Open submenu "System info"

1. Select the "System info" submenu (Fig. 174/2) with the arrow keys [up] (Fig. 174/3) and [down] (Fig. 174/5).
2. Confirm the selection with [OK] (Fig. 174/4).

⇒ The "42 System info" submenu appears on the display (Fig. 175/1) showing the values "Rail length" (Fig. 175/2), "Cleaning time" (Fig. 175/3) and "Rotor speed" (Fig. 175/4).

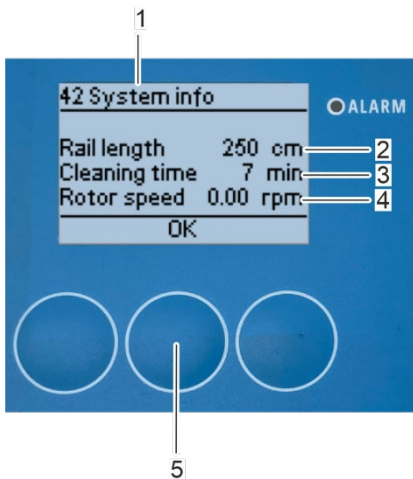

Fig. 175: Submenu "System info"

3. Press [OK] (Fig. 175/5) to return to the submenu "4 Status" (Fig. 176/1).

⇒ The "4 Status" submenu (Fig. 176/1) appears on the display.

Open submenu "Input signals"

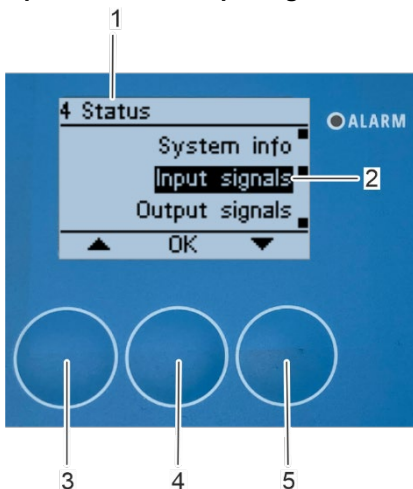

Fig. 176: Open submenu "Input signals"

1. Select the "Input signals" submenu (Fig. 176/2) with the arrow keys [up] (Fig. 176/3) and [down] (Fig. 176/5).
2. Confirm the selection with [OK] (Fig. 176/4).

⇒ The "43 Input signals" submenu appears on the display (Fig. 177/1) showing the actual status of the "Start input" (Fig. 177/2), the "Inner sensor" (Fig. 177/3), the "Outer sensor" (Fig. 177/4) and the "0-10 V input" (Fig. 177/5).

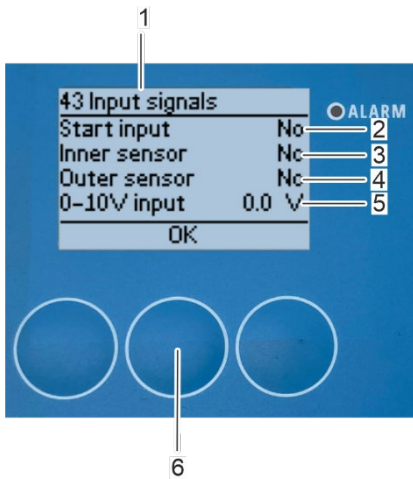

Fig. 177: Submenu "43 Input signals"

Open submenu "Output signals"

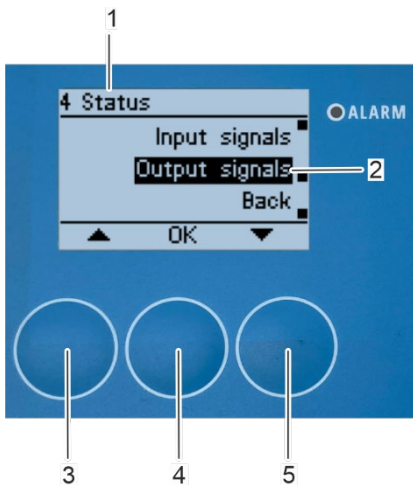

Fig. 178: Open submenu "Output signals"

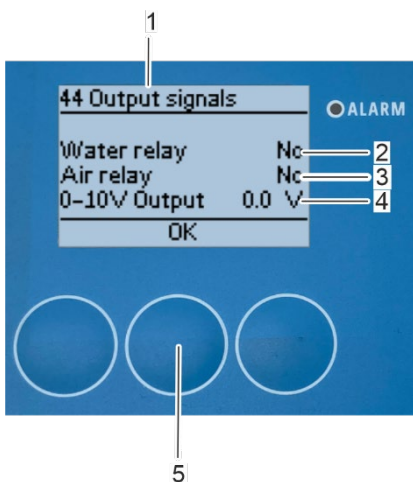

Fig. 179: Submenu „44 Output signals“



The input signals "Start Input" (Fig. 177/2), "Inner Sensor" (Fig. 177/3) and "Outer Sensor" (Fig. 177/4) show "Yes" if there is an input signal. The "0-10V Input" (Fig. 177/5) shows the currently applied voltage in a range from 0 to 10 V.

3. Press [OK] (Fig. 177/6) to return to the submenu "4 Status" (Fig. 178/1).

⇒ The "4 Status" submenu appears on the display (Fig. 178/1).

1. Select the "Output signals" submenu (Fig. 178/2) with the arrow keys [up] (Fig. 178/3) and [down] (Fig. 178/5).
2. Confirm the selection with [OK] (Fig. 178/4).

⇒ The "44 Output signals" submenu appears on the display (Fig. 179/1) showing the actual status of the "Water relay" (Fig. 179/2), the "Air relay" (Fig. 179/3) and the "0-10 V Output" (Fig. 179/4).



The output signals "Water relay" (Fig. 179/2) and "Air relay" (Fig. 179/3) show "Yes" if there is an input signal. The "0-10V Output" (Fig. 179/4) shows the currently applied voltage in a range from 0 to 10 V.

3. Press [OK] (Fig. 179/5) to return to the submenu "4 Status" (Fig. 180/1).

⇒ The "4 Status" submenu appears on the display (Fig. 180/1).

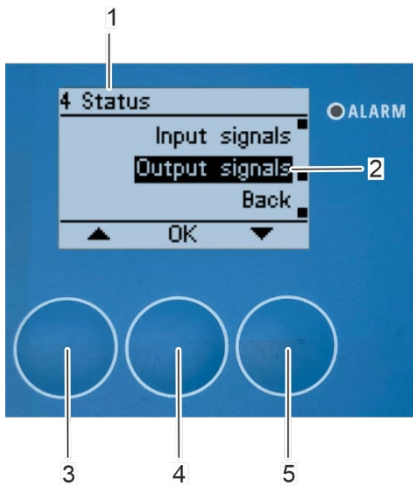

Fig. 180: Submenu "4 Status"

7.7. Fault indications

Open submenu "Alarms"

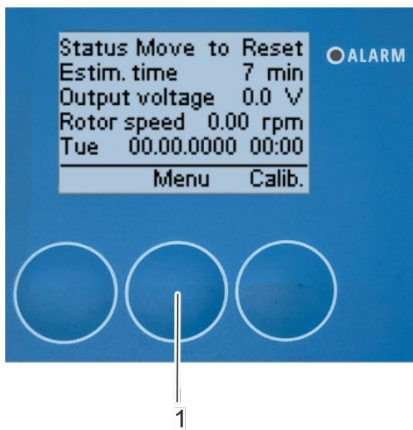

Fig. 181: Open main menu

1. Press [Menu] (Fig. 181/1) to open the "1 Main menu" menu (Fig. 182/1).

⇒ The "1 Main menu" menu appears on the display (Fig. 182/1).

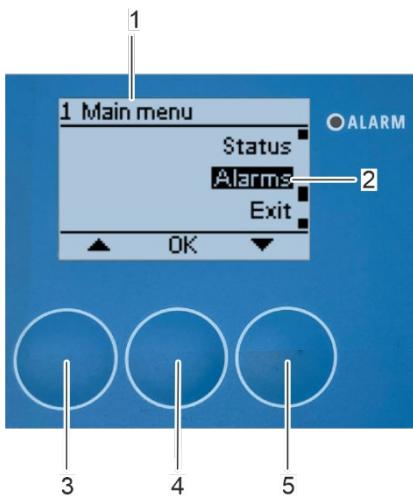

Fig. 182: Open submenu "Alarms"

2. Select the "Alarms" submenu (Fig. 182/2) with the arrow keys [up] (Fig. 182/3) and [down] (Fig. 182/5).
3. Confirm the selection with [OK] (Fig. 182/4).

⇒ The "5 Alarms" submenu appears on the display (Fig. 183/1).

Open submenu “Active alarms”

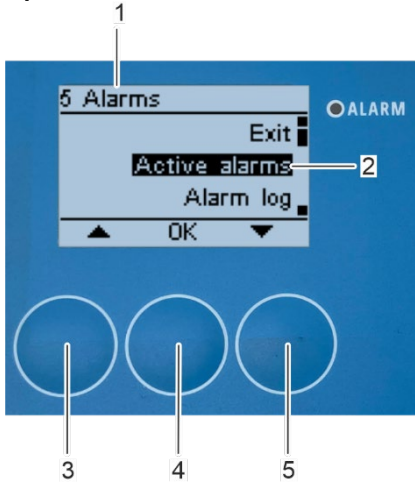

Fig. 183: Open submenu “Active alarms”

1. Select the “Active alarms” submenu (Fig. 183/2) with the arrow keys [up] (Fig. 183/3) and [down] (Fig. 183/5).
2. Confirm the selection with [OK] (Fig. 183/4).

⇒ The “51 Active alarms” submenu appears on the display (Fig. 184/1) showing a “listing of the active alarms” (Fig. 184/2).

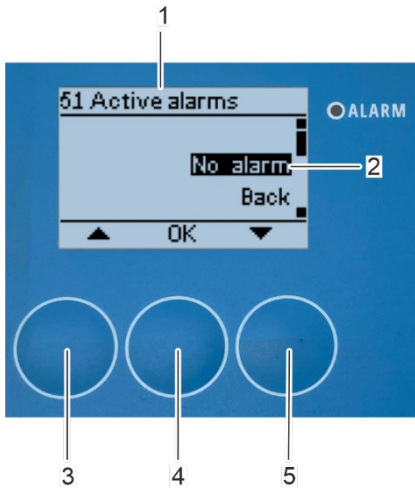

Fig. 184: Listing of active alarms

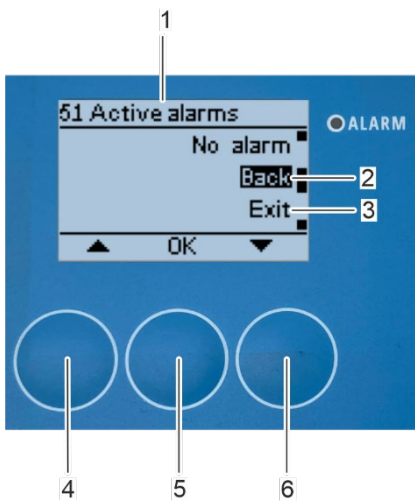

Fig. 185: Leave submenu “51 Active alarms”

3. Select [Back] (Fig. 185/2) to return to “5 Alarms” submenu (Fig. 186/1) or [Exit] (Fig. 185/3) to leave the menu and return to the home screen with the arrow keys [up] (Fig. 185/4) and [down] (Fig. 185/6).
4. Confirm the selection with [OK] (Fig. 185/5).

Open submenu "Alarm log"

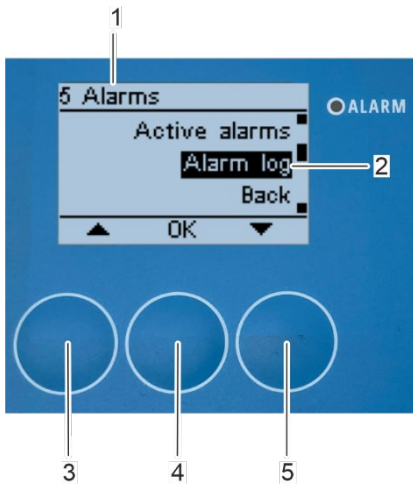

Fig. 186: Open submenu „Alarm log“

1. Select the "Alarm log" submenu (Fig. 186/2) with the arrow keys [up] (Fig. 186/3) and [down] (Fig. 186/5).
2. Confirm the selection with [OK] (Fig. 186/4).

⇒ The "52 Alarms" submenu appears on the display (Fig. 187/1) showing a "listing of the registered alarms" (Fig. 187/2).

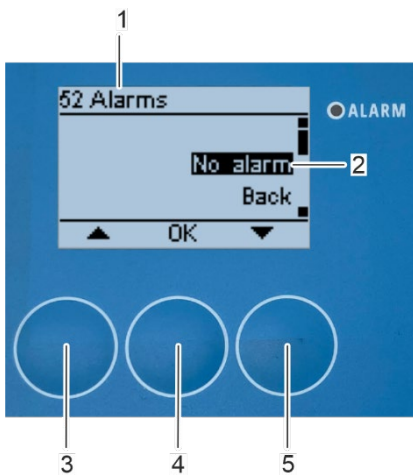

Fig. 187: Listing of registered alarms

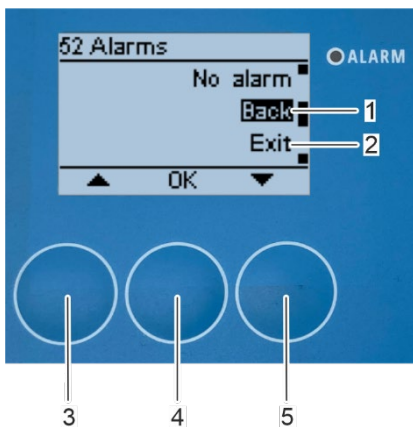

Fig. 188: Leave submenu "52 Alarms"

3. Select [Back] (Fig. 188/1) to return to the "5 Alarms" submenu (Fig. 186/1) or [Exit] (Fig. 188/2) to leave the menu and return to the home screen with the arrow keys [up] (Fig. 188/3) and [down] (Fig. 188/5).
4. Confirm the selection with [OK] (Fig. 188/4).

Alarm messages popping up during operation



The alarm messages described below are also displayed in abbreviated form in submenu "51 Active alarms" and saved in submenu "52 Alarms". To rectify the alarms described, see chapter 9 Troubleshooting on page 118. If an alarm message appears, that is not described below, read chapter 9 Troubleshooting on page 118 or contact Klingenburg GmbH ↗ Manufacturer's contact details on page 4.

Inner or outer sensor alarm

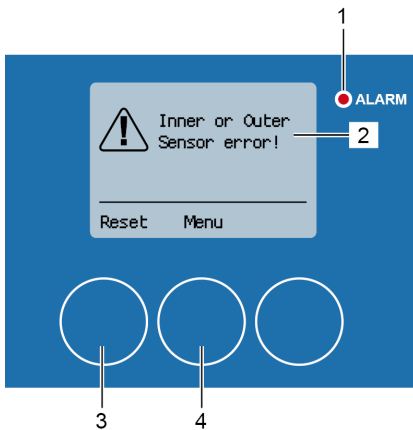

Fig. 189: Inner or outer sensor alarm



The alarm message "Inner or Outer sensor error!" (Fig. 189/2) occurs during the cleaning process if there is a problem with the inner and/or outer proximity sensor. The red alarm LED (Fig. 189/1) lights up.

1. Refer to ↗ chapter 9 Troubleshooting on page 118 and rectify the error.
2. Reset the alarm message with [Reset] (Fig. 189/3).

⇒ The cleaning process continues.



If the alarm message is reset without first rectifying the error, the alarm message appears again. The "1 Main menu" menu can be called up via [Menu] (Fig. 189/4), e.g. to check the signal status of the proximity sensors ↗ chapter 7.6 Status indicators on page 105.

Clock sensor alarm

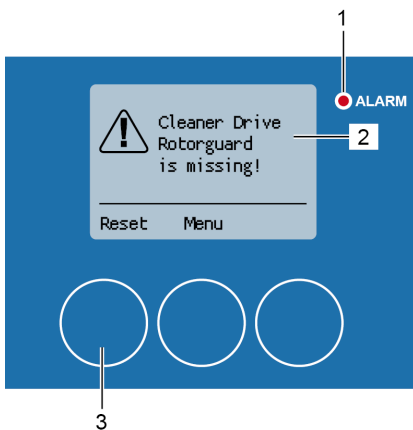

Fig. 190: Clock sensor alarm



The alarm message "Cleaner Drive Rotorguard is missing!" (Fig. 190/2) occurs during the cleaning process if there is a problem with the clock sensor. The red alarm LED (Fig. 190/1) lights up.

1. Refer to ↗ chapter 9 Troubleshooting on page 118 and rectify the error.
2. Reset the alarm message with [Reset] (Fig. 190/3).

⇒ The cleaning process continues.



If the alarm message is reset without first correcting the error, the alarm message appears again.

Modbus communication alarm

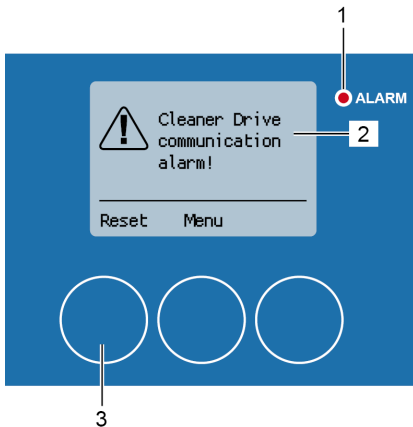



Fig. 191: Modbus communication alarm



The alarm message “Cleaner Drive communication alarm!” (Fig. 191/2) occurs during the cleaning process if there is a problem with the modbus communication between the rotor cleaner control and the rotor cleaner drive. The red alarm LED (Fig. 191/1) lights up.

1. Refer to  chapter 9 Troubleshooting on page 118 and rectify the error.

⇒ The alarm message is automatically reset as soon as an error-free modbus communication is detected by the rotor cleaner control and the cleaning process continues.



If the alarm message is reset manually via [Reset] (Fig. 191/3) without first rectifying the error, the alarm message appears again.

Rotor drive alarm

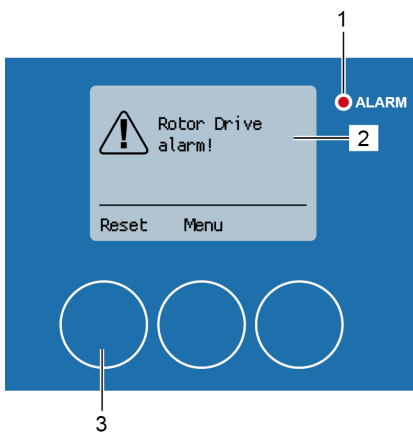



Fig. 192: Rotor drive alarm



The alarm message “Rotor drive alarm!” (Fig. 192/2) is displayed during the cleaning process if there is a problem with the bypass between terminals 21 and 22 on the rotor cleaner control terminal block. The red alarm LED (Fig. 192/1) lights up.

1. Refer to  chapter 9 Troubleshooting on page 118 and rectify the error.

⇒ The alarm message is automatically reset as soon as the bypass between terminals 21 and 22 on the rotor cleaner control terminal block is detected by the rotor cleaner control and the cleaning process continues.



If the alarm message is reset manually via [Reset] (Fig. 192/3) without first correcting the error, the alarm message appears again.

Motor phase alarm

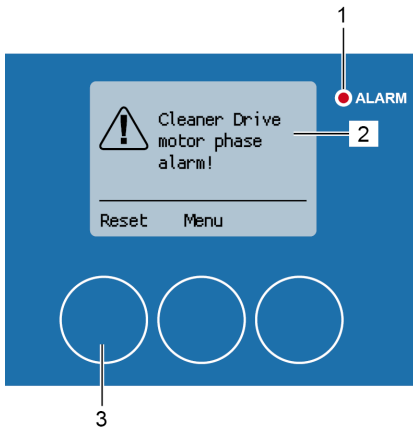

Fig. 193: Motor phase alarm



The alarm message “Cleaner Drive motor phase alarm!” (Fig. 193/2) is displayed during the cleaning process if there is a problem with the connection of stepper motor of the cleaning rail. The red alarm LED (Fig. 193/1) lights up.

1. Refer to chapter 9 Troubleshooting on page 118 and rectify the error.
2. Reset the alarm message with [Reset] (Fig. 193/3).

⇒ The cleaning process continues.



If the alarm message is reset without first correcting the error, the alarm message appears again.

Inner sensor signal alarm

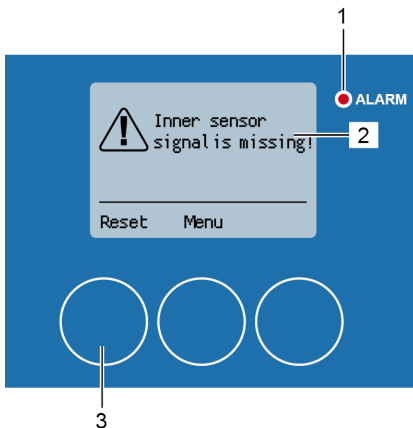

Fig. 194: Inner sensor signal alarm



The alarm message “Inner sensor signal is missing!” (Fig. 194/2) is displayed during the cleaning process if there is a problem with the proximity sensor in the centre of the rotor. For example, if the proximity sensor in the centre of the rotor emits a new signal (e.g. due to contamination) after it has already given a signal by recognizing the cleaning carriage. The red alarm LED (Fig. 194/1) lights up.

1. Refer to chapter 9 Troubleshooting on page 118 and rectify the error.
2. Reset the alarm message with [Reset] (Fig. 194/3).

⇒ The cleaning process continues.



If the alarm message is reset without first correcting the error, the alarm message appears again. The “1 Main menu” menu can be called up via [Menu] (Fig. 194/4), e.g. to check the signal status of the proximity sensor in the centre of the rotor chapter 6.5 Status indicators on page 89.

Outer sensor signal alarm

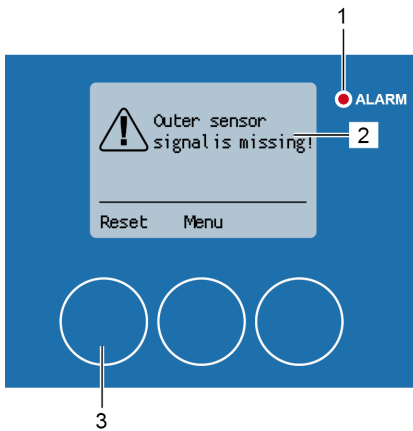

Fig. 195: Outer sensor signal alarm



The alarm message “Outer sensor signal is missing!” (Fig. 195/2) is displayed during the cleaning process if there is a problem with the proximity sensor on the circumference of the rotor. The red alarm LED (Fig. 195/1) lights up.

1. Refer to ↗ chapter 9 Troubleshooting on page 118 and rectify the error.
2. Reset the alarm message with [Reset] (Fig. 195/3).

⇒ The cleaning process continues.



If the alarm message is reset without first correcting the error, the alarm message appears again. The menu “1 Main menu” can be called up via [Menu] (Fig. 195/4), e.g. to check the signal status of the proximity sensor on the circumference of the rotor ↗ chapter 6.5 Status indicators on page 89.

Cleaner drive undervoltage alarm

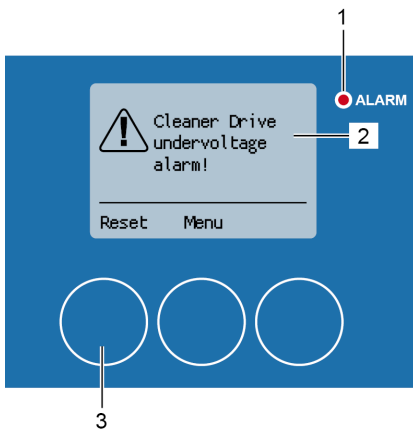

Fig. 196: Cleaner drive undervoltage alarm



The alarm message “Cleaner Drive undervoltage alarm!” (Fig. 196/2) is displayed during the cleaning process if there is a problem with the power supply of the rotor cleaner drive. The red alarm LED (Fig. 196/1) lights up.

1. Refer to ↗ chapter 9 Troubleshooting on page 118 and rectify the error.
2. Reset the alarm message with [Reset] (Fig. 196/3).

⇒ The cleaning process continues.



If the alarm message is reset without first rectifying the error, the alarm message appears again.

8. Maintenance

8.1. Maintenance safety instructions

Electrical voltage



DANGER!

Risk of fatal injury from electric current!

In case of contact with live parts, there is a risk of fatal injury through electric shock.

- Only qualified electricians may work on electrical components.
- Before doing any work on the electrical system, switch it off and secure it against being switched on again.
- Even after the electrical system has been switched off, dangerous electrical voltage is still present on internal circuit components. Wait at least 5 minutes for the residual voltage to dissipate before working on electrical components.
- Check that there is no voltage before any intervention.

Cleaning carriage



WARNING!

Danger of being crushed and drawn in by the cleaning carriage!

Body parts can be crushed or hair and limbs pulled in on the cleaning carriage.

- Before carrying out any work on the cleaning carriage, switch off the machine and secure it against being switched on again.

Pressurised supply lines



WARNING!

Risk of injury from pressurised supply lines!

During and after operation, the compressed air and water lines are under pressure. Working on pressurised components can lead to serious injuries.

- Prior to any work on the compressed air and water lines, depressurise them.

High pressure jets



WARNING!

Risk of injury from compressed air and water escaping at high pressure from the nozzles!

Compressed air and water escaping at high pressure from the nozzles of the cleaning carriage during the cleaning process can lead to serious injuries.

- Before doing any work on the nozzles, switch off the machine and secure it against being switched on again and disconnect it from the media supply.

8.2. Maintenance table

The table below indicates the maintenance operations required for optimum and trouble-free operation of the machine.

The operator is responsible for carrying out the maintenance work and complying with the minimum maintenance intervals. If you have any questions about maintenance work and intervals, contact the manufacturer ↗
Manufacturer's contact details on page 4.

Interval	Maintenance work	Personnel
At least annually	Clean the cleaning rail.	Service technician
	Check toothed belt tension, retighten if necessary. ↗ Chapter 6.2.1 Cleaning rail on page 39.	Service technician
	Check the free movement of the deflection rollers. ↗ Chapter 6.2.1 Cleaning rail on page 39.	Service technician
	Check the functionality of the solenoid valves, replace if necessary. ↗ Chapter 7.3.9 Perform hardware test on page 93.	Service technician Electrician
	Check the compressed air connections for leaks. ↗ Chapter 6.2.5 Compressed air supply on page 54.	Service technician
	Check water connections for leaks. ↗ Chapter 6.2.4 High-pressure water supply on page 54.	Service technician

9. Troubleshooting

Error description	Display indication	Cause	Solution	Personnel
Motor does not rotate/cleaning carriage does not move	„Inner or Outer sensor error!“	Stepper motor is not connected to the cleaner drive.	Check stepper motor connection, replace or repair if necessary [↗] <i>Chapter 6.3.2 Rotor cleaner drive on page 72.</i> Reset alarm message.	Electrician
		Toothed belt tension is too low or toothed belt is torn.	Check condition and tension of the toothed belt, replace if necessary. Reset alarm message.	Service technician
Outer sensor cannot be reached or does not switch.	„Outer sensor signal is missing!“	Stepper motor defective.	Check the stepper motor, replace if necessary. Reset alarm message.	Electrician
		Foreign objects on the cleaning rail.	Check the cleaning rail for foreign objects, remove if necessary. Reset alarm message.	Service technician
		Cleaning carriage defective.	Check the cleaning carriage, replace if necessary. Reset alarm message.	Service technician
		Toothed belt tension is too low or toothed belt is torn.	Check condition and tension of the toothed belt, replace if necessary. Reset alarm message.	Service technician
		No signal from outer sensor.	Check the cable and the connection of the outer sensor, replace sensor if necessary. Reset alarm message.	Electrician
		Outer sensor defective.	Check the outer sensor. The outer sensor is designed as a normally closed switch. In switched state, the LED at the end of the sensor must be off. Replace if necessary. Reset alarm message.	Electrician

Error description	Display indication	Cause	Solution	Personnel
Inner sensor cannot be reached or does not switch.	„Inner sensor signal is missing!“	Stepper motor defective.	Check the stepper motor, replace if necessary. Reset alarm message.	Electrician
		Foreign objects on the cleaning rail.	Check the cleaning rail for foreign objects, remove if necessary. Reset alarm message.	Service technician
		Cleaning carriage defective.	Check the cleaning carriage, replace if necessary. Reset alarm message.	Service technician
		Toothed belt tension is too low or toothed belt is torn.	Check condition and tension of the toothed belt, replace if necessary. Reset alarm message.	Service technician
		No signal from inner sensor.	Check the cable and the connection of the inner sensor, replace sensor if necessary. Reset alarm message.	Electrician
		Inner sensor defective.	Check the inner sensor. The inner sensor is designed as a normally closed switch. In switched state, the LED at the end of the sensor must be off. Replace if necessary. Reset alarm message.	Electrician
Rotary heat exchanger does not rotate.	„Cleaner Drive Rotorguard is missing!“	Incorrect connection of 0-10 V voltage output signal on the rotor cleaner control.	Check the connection of the 0-10 V voltage output signal on the rotor cleaner control. Check if there is a voltage control signal, repair if necessary. Reset alarm message.	Electrician
		Incorrect connection on rotary heat exchanger control.	Check the connection of the 0-10 V control signal on the rotary heat exchanger control, correct if necessary. Reset alarm message.	Electrician
		Wrong polarity on rotor control.	Check polarity on rotor control, correct if necessary. Reset alarm message.	Electrician

Error description	Display indication	Cause	Solution	Personnel
		Defective terminals for 0-10 V voltage output signal on the rotor cleaner control.	Replace rotor cleaner control, contact Klingenburg for replacement. Reset alarm message.	Electrician
		Rotary heat exchanger motor defective.	Check rotary heat exchanger motor, replace if necessary. Reset alarm message.	Electrician
Cleaning carriage does not move.	„Cleaner Drive Rotorguard is missing!”	No signal from clock sensor.	Check the connection of the clock sensor on the rotor cleaner control, repair if necessary. Reset alarm message.	Electrician
		Clock sensor cable defective.	Check clock sensor cable, replace rotor guard if necessary. Reset alarm message.	Electrician
		Clock sensor contactor on rotary heat exchanger defective or missing.	Check clock sensor contactor, mount or replace if necessary. Reset alarm message.	Electrician
No communication between rotor cleaner control and rotor cleaner drive.	„Cleaner Drive communication alarm!”	Modbus communication is missing.	Check modbus connection between rotor cleaner control and rotor cleaner drive, repair if necessary. The alarm message is reset automatically when solved.	Electrician
Rotor drive alarm has been triggered	„Rotor drive alarm!”	Bridging between terminals 21 and 22 on the rotor cleaner control is missing.	Create a bridging between terminals 21 and 22 on the rotor cleaner control. The alarm message is reset automatically when solved.	Electrician
No water supply during the cleaning process.		Water supply is off.	Turn on water supply.	Service technician
		Water supply is not connected to the water solenoid valve.	Connect the water supply to the water solenoid valve.	Service technician
		Water supply not properly connected to the water solenoid valve.	Check the water supply connection at the water solenoid valve, correct it if necessary.	Service technician

Error description	Display indication	Cause	Solution	Personnel
		No connection between water solenoid valve and high-pressure hot water nozzle.	Connect the output of the water solenoid valve with the high-pressure hot water nozzle.	Service technician
		Lack of function of the water solenoid valve.	Check the water solenoid valve, replace if necessary.	Service technician
		Water solenoid valve electrically not properly connected to the rotor cleaner control.	Check the electrical connection of the water solenoid valve on the rotor cleaner control, correct it if necessary.	Electrician
No compressed air supply during the cleaning process.		Compressed air supply is off.	Turn on compressed air supply.	Service technician
		Compressed air supply is not connected to the compressed air solenoid valve.	Connect the compressed air supply to the compressed air solenoid valve.	Service technician
		Compressed air supply not properly connected to the compressed air solenoid valve.	Check the compressed air supply connection at the compressed air solenoid valve, correct it if necessary.	Service technician
		No connection between compressed air solenoid valve and compressed air nozzle.	Connect the output of the compressed air solenoid valve with the compressed air nozzle.	Service technician
		Lack of function of the compressed air solenoid valve.	Check the compressed air solenoid valve, replace if necessary.	Service technician
		Compressed air solenoid valve not properly connected to the rotor cleaner control.	Check the electrical connection of the compressed air solenoid valve on the rotor cleaner control, correct it if necessary.	Electrician.
Display off/without function.		Power supply missing.	Switch on the power supply.	User
		Fuse in rotor cleaner control (T 800 mA) defective.	Check the fuse, replace if necessary.	Electrician
		Rotor cleaner control defective.	Replace rotor cleaner control, contact Klingenburg for replacement.	Electrician

Error description	Display indication	Cause	Solution	Personnel
Overvoltage alarm triggered.	„Cleaner Drive overvoltage alarm!“	Input voltage too high.	Check connections L, N and PE on the the rotor cleaner control, correct if necessary. Reset alarm message.	Electrician
Undervoltage alarm triggered.	„Cleaner Drive undervoltage alarm!“	Input voltage too low.	Check connections L, N and PE on the the rotor cleaner control, correct if necessary. Reset alarm message.	Electrician
Overcurrent alarm triggered.	„Cleaner Drive overcurrent alarm!“	Short circuit in the stepper motor cable.	Check stepper motor cable, replace if necessary. Reset alarm message.	Electrician
		Short circuit in the stepper motor connector.	Check stepper motor connector, replace the whole cable with connector if necessary. Reset alarm message.	Electrician
		Short circuit in stepper motor.	Check stepper motor, replace if necessary. Reset alarm message.	Electrician
Overheat stop alarm triggered.	„Cleaner Drive overheat stop alarm!“	Temperature inside the rotor cleaner drive too high.	Allow cleaner drive to cool down. Check if air can flow freely around the cooling fins of the rotor cleaner drive, position cleaner drive in a place with better air flow if necessary. Reset alarm message.	Electrician
Motor blocked.	„Cleaner Drive rotor blocked alarm!“	Cleaning carriage is stuck.	Check cleaning carriage, remove the blocking reason if necessary. Reset alarm message.	Service technician
		Deflector rolls are stuck.	Check deflector rolls, remove the blocking reason if necessary. Reset alarm message.	Service technician
		Toothed belt is stuck.	Check toothed belt, remove the blocking reason if necessary. Reset alarm message.	Service technician

Error description	Display indication	Cause	Solution	Personnel
Motor phase alarm triggered.	„Cleaner Drive motor phase alarm!”	Stepper motor cable not properly connected to the rotor cleaner drive.	Check connection of the stepper motor cable on the rotor cleaner drive, correct if necessary. Reset alarm message.	Electrician
		Stepper motor cable connector not properly connected.	Check the stepper motor cable connector, plug them in correctly or replace all cables along with the connector if necessary. Reset alarm message.	Electrician
		Stepper motor cables defective.	Check the stepper motor cables, replace them if necessary. Reset alarm message.	Electrician
Hardware fault alarm triggered.	„Cleaner Drive hardware fault alarm!”	Hardware error in the rotor cleaner drive.	Replace rotor cleaner drive, contact Klingenburg for replacement.	Electrician

10. Disassembly and disposal

Electrical system



DANGER!

Danger to life due to electric current!

There is a danger to life in case of contact with live components. Electrical components which are switched on can perform uncontrolled movements and lead to serious injuries.

- Before starting disassembly, switch off and permanently disconnect the electrical supply.

Pressurised lines



WARNING!

Risk of injury from pressurised lines!

Compressed air and water lines under pressure can swing out uncontrollably during disassembly and water can spray out of the line under high pressure and cause serious injuries.

- Before disassembly, switch off the compressed air and water supply and depressurise the lines.

Improper disassembly



WARNING!

Risk of injury from improper disassembly!

Stored residual energy, angular components, points and corners on or in the machine or on the required tools can cause injuries.

- Make sure there is sufficient space before starting work.
- Be careful with exposed sharp-edged components.
- Pay attention to order and cleanliness at the workplace! Components and tools lying loosely on top of each other or lying around are sources of accidents.
- Disassemble components professionally.
- Secure components to prevent them from falling or tipping over.
- If anything is unclear, consult the manufacturer.

Environmental protection



ENVIRONMENTAL PROTECTION!

Danger to the environment due to incorrect disposal!

Improper disposal can pose a hazard to the environment.

- Have electrical components, lubricants and other auxiliary materials disposed of by approved specialist companies.
- If in doubt, obtain information on environmentally friendly disposal from the local municipal authority or special disposal companies.

Personnel:

- Service technician
- Electrician

Protective equipment:

- Protective clothing
- Safety shoes
- Safety gloves

Requirements:

- The machine is switched off and secured against being switched on again ↪ *Operating manual for the building control system.*

Disassembling

1. Physically disconnect the entire system from all energy sources.
2. Disassemble components professionally.
3. Clean the disassembled components and dispose of them properly.

Disposal

4. Dispose of the components of the machine as follows:
 - Plastics:
 - Send plastics for recycling
 - Metals:
 - Scrap metals
 - Electrical components
 - Have electrical components disposed of by authorised specialist companies